

K: 17,02

K: 17,04

Suðvestur
1 : 100

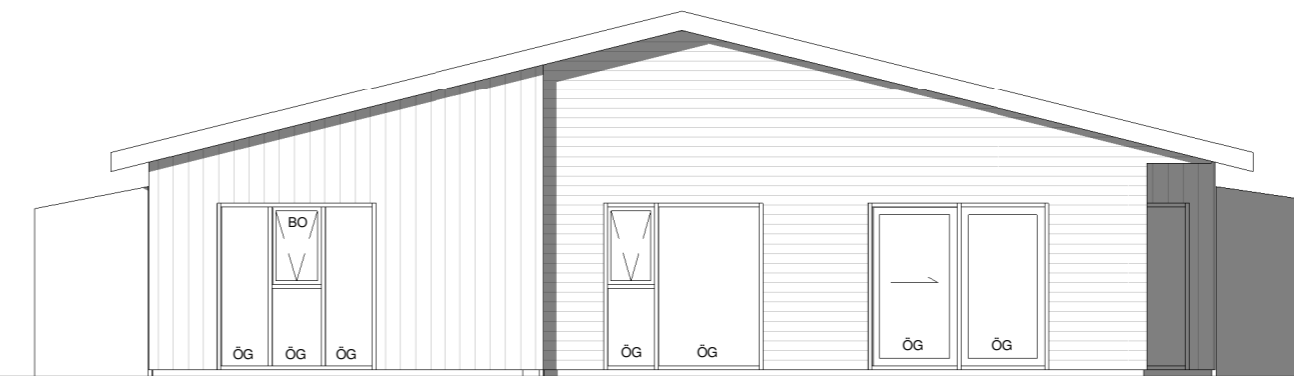

K: 16,82

K: 17,02

Norðvestur
1 : 100



K: 16,79

K: 16,82

Norðaustur
1 : 100

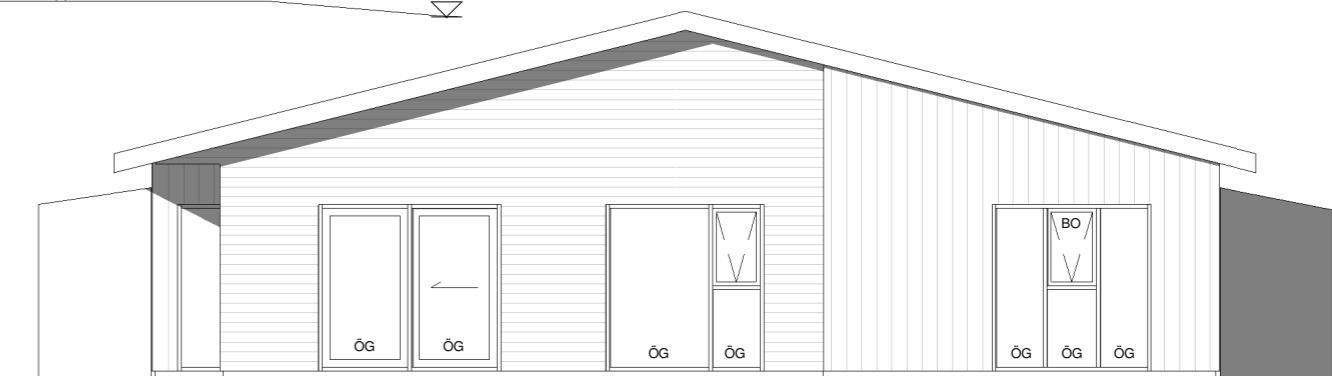

K: 17,04

K: 16,79

Suðaustur
1 : 100

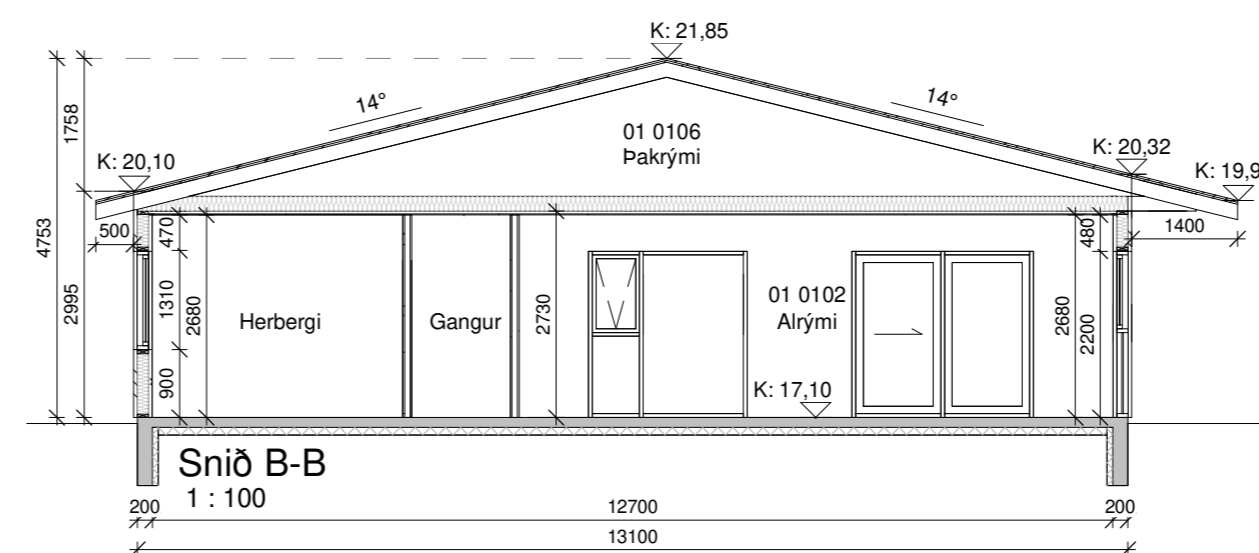
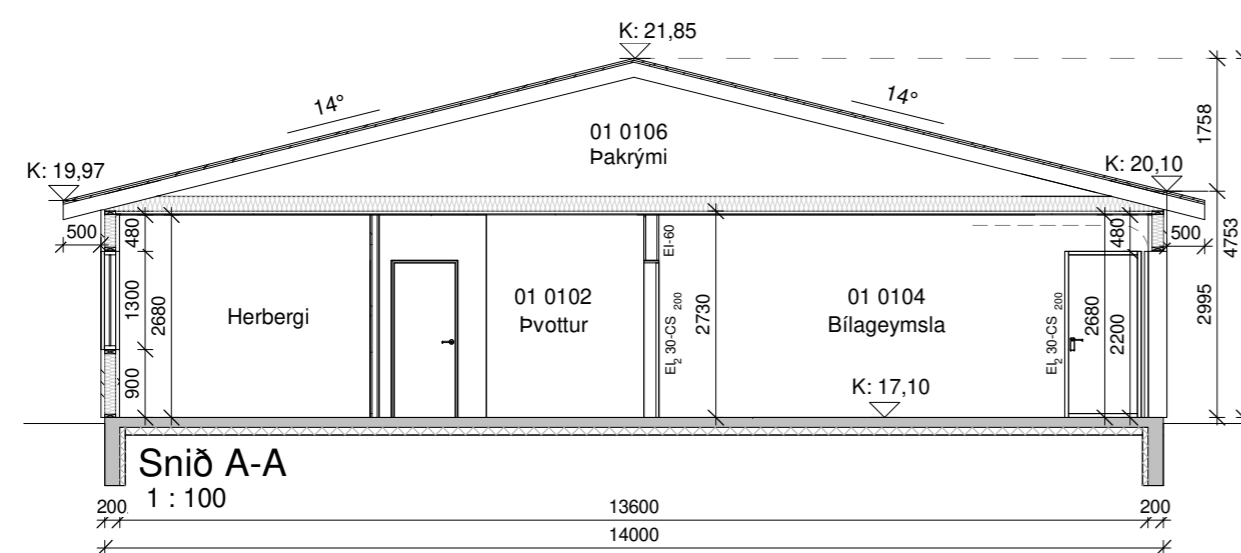

Öll mál eru í millimetrum, nema annað sé tekið fram.

Nr.	Breyting	Dagsetning	Yfirfarid

VERKHEITI: Hamravík 10-12 800 Selfoss	TEIKNINÚMÉR: 100
VERKHLUTI: Aðalteikningar Útlit og snið	ÚTGÁFA: A1
Teiknað: Þórunn Sigþórsdóttir kt. 060874-3959	Blaðstærð: A2
Hönnuður: Björgvin Viglundsson kt. 040546-2009	Samþykkt: Björgvin Viglundsson
Hönnunarstjóri: Björgvin Viglundsson kt. 040546-2009	Samþykkt: Björgvin Viglundsson
	Dagsetning: 07/01/22
	Frumútgáfa: 07/01/22
	VERKNR: 21-195
	MKV: 1:100

LARSEN
HÖNNUN OG RAÐGJÖF

Bent Larsen Fróðason
Byggingrafæðingur B.Sc
Sími 844-7699
tölvupóstur: bent@larsenhr.is

Hamravík 10-12	M ² (brúttó)	M ³ (brúttó)
0101 Íbúð	150,0 m ²	448,5 m ³
0102 Íbúð	150,0 m ²	448,5 m ³
0103 Bílageymsla	34,3 m ²	102,6 m ³
0104 Bílageymsla	34,3 m ²	102,6 m ³
0105 Pakrými	184,3 m ²	162,2 m ³
0106 Pakrými	184,3 m ²	162,2 m ³
Botnplata	368,6	73,7 m ³
Flatarmál lóðar samtals	1140,0 m ²	
Nýtingahlutfall	0,32	
Bílastæði	2 við hvora íbúð	



Skýringar.

- Útgangur
- Rýmingarleið
- Reykskynjari
- Loftræsting
- Vélræn loftræsting
- Handslökkvitæki
- Hleðslustöð
- Handklæðaofn
- Gólfniðurfall
- Gegnumstreymisniðurfal
- Björgunarp
- Öryggisgler
- Gólfkóti á frágengið gólf
- Inntök fyrir hitaveitu, vatnsveitu, rafmagn og síma
- Matshluti
- Brunanótstaða veggja/hurða
- Byggingareitur
- Lóðarmörk

G=17,02
Grunnmynd
1 : 100

Öll mál eru í millimetrum, nema annað sé tekið fram.

Nr.	Breyting	Dagsetning	Yfirarið
VERKHEITI: Hamravík 10-12 800 Selfoss		TEIKNINÚMÉR: 101	
VERKHLUTI: Aðalteikningar Grunnmynd		ÚTGÁFA: A1	
Teiknað: Þórunn Sigþórsdóttir kt. 060874-3959		Bláðstaerð: A2	
Höfundur: Björgvin Viglundsson kt. 040546-2009	Samþykkt:	Dagsetning: 07/01/22	
Hönnunarstjóri: Björgvin Viglundsson kt. 040546-2009	Samþykkt:	Frumútgáfa: 07/01/22	
LARSEN HÖNNUN OG RAÐGJÖF		VERKNR: 21-195	
Bent Larsen Fróðsson Byggingafræðingur B.Sc Sími 844-7699 tölvupóstur: bent@larsenhr.is		MKV: 1:100	

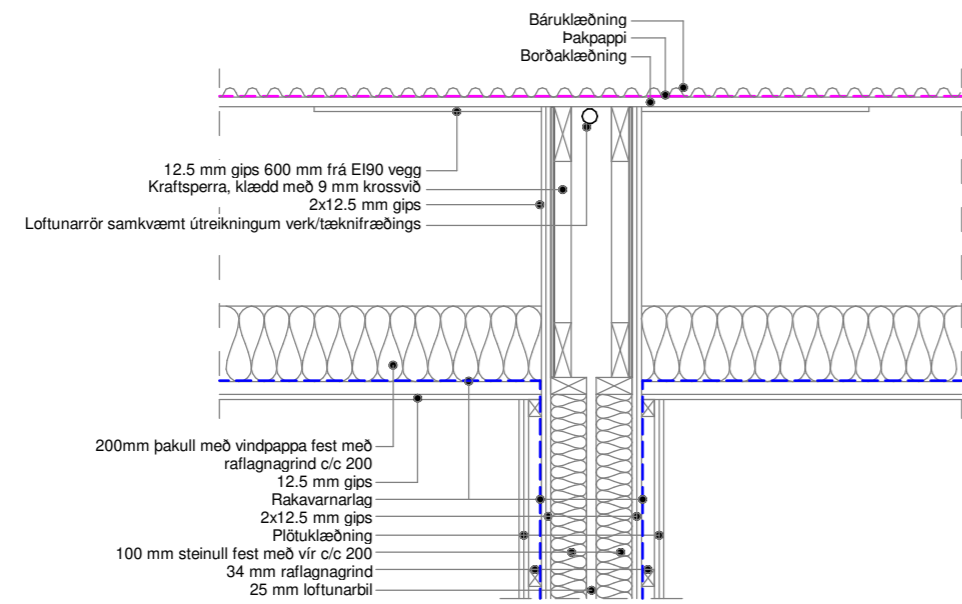

Samskeyti, innhorn og úthorn skal þétta með eldþolnu kitti svo ekki verði reyksmit.

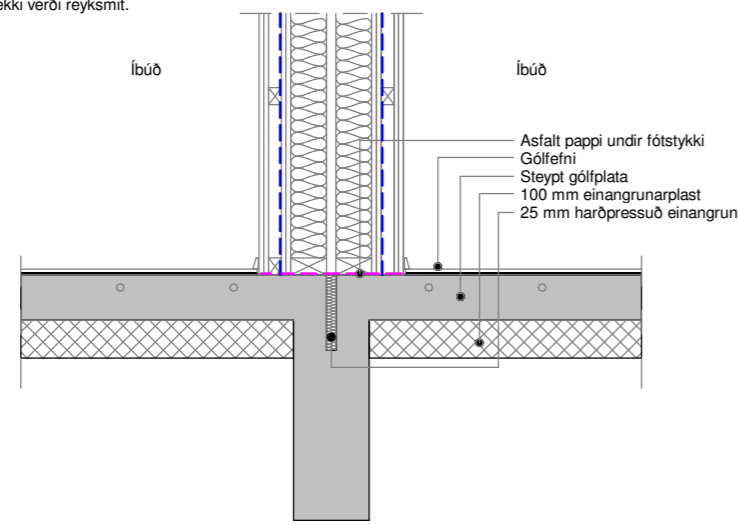

Lóðrétt deili í EI90 vegg
1:20

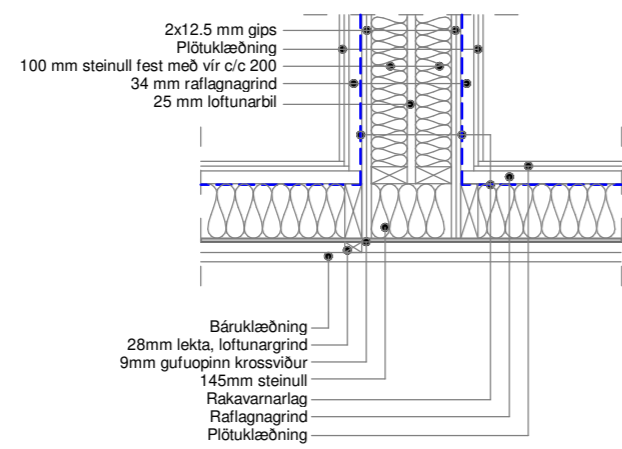

Lárétt deili í EI90 vegg
1:20

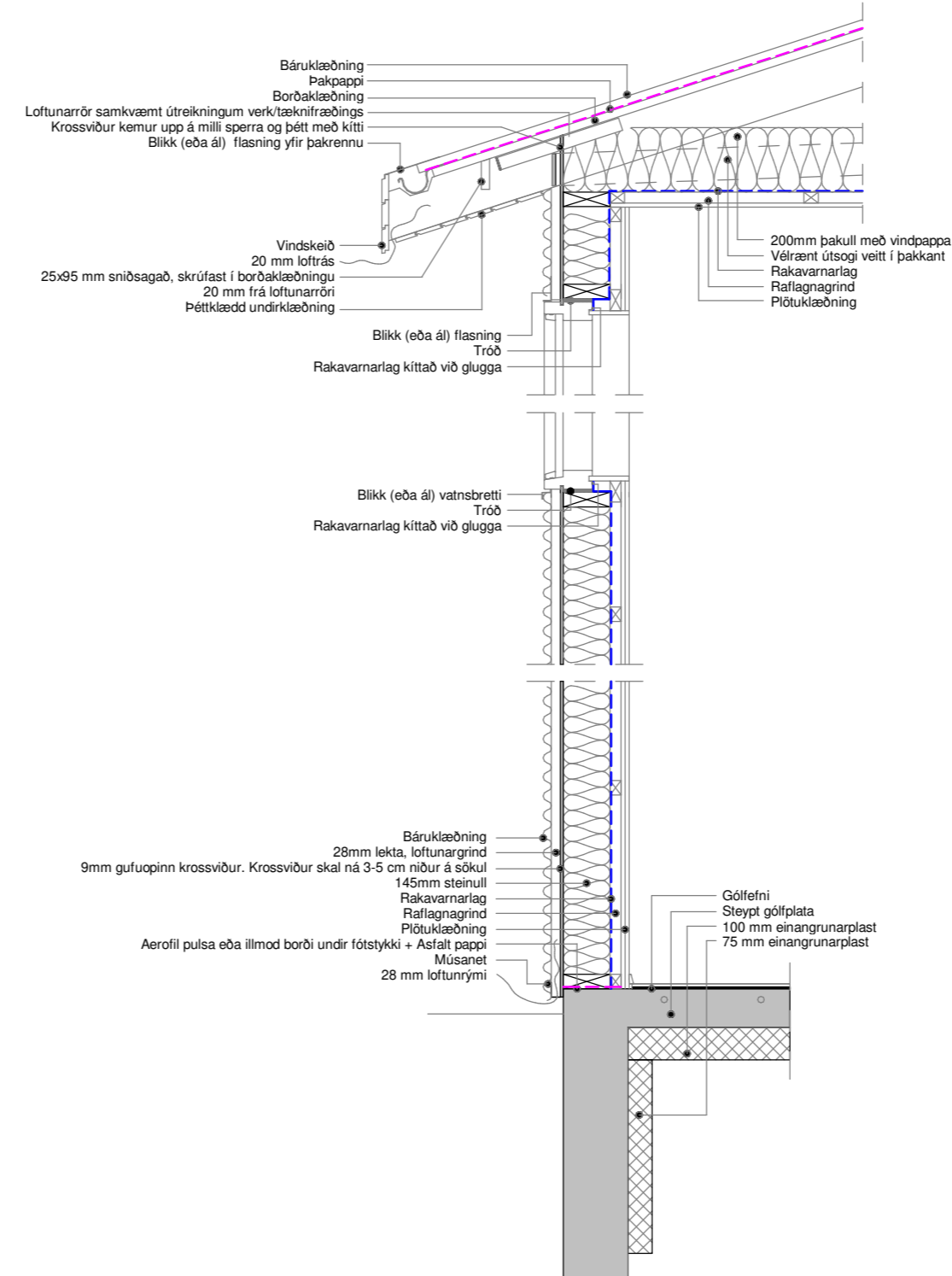

Lóðrétt deili í útvegg
1:20

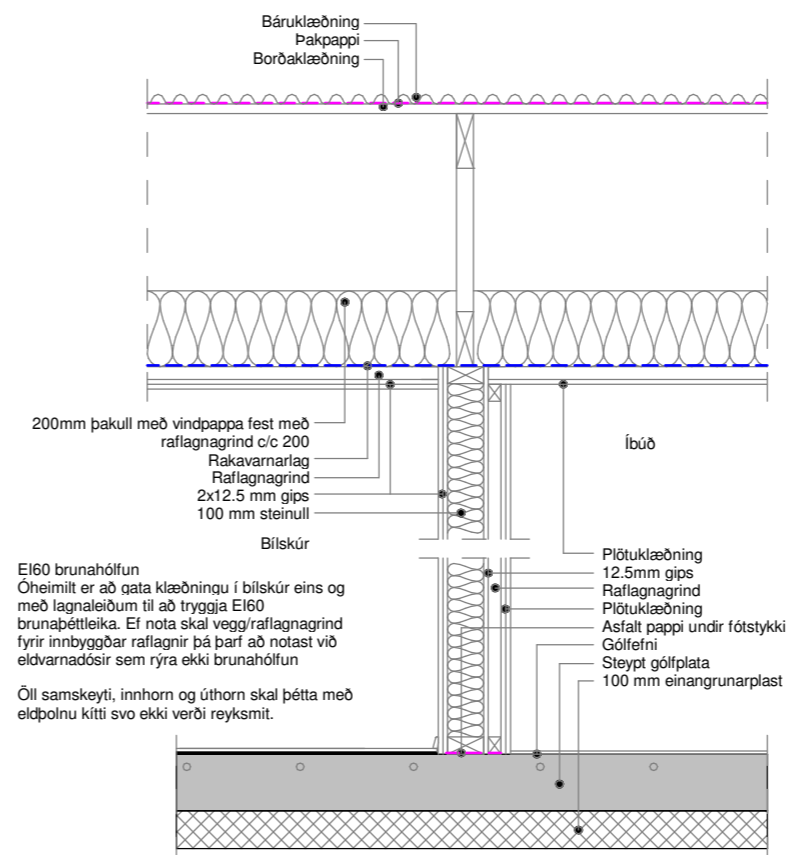

Lóðrétt deili í EI60 vegg
1:20

Öll mál eru í millimetrum, nema annað sé tekið fram.

Nr.	Breyting	Dagsetning	Yfirarið
VERKHEITI: Hamravík 10-12 800 Selfoss		TEIKNINÚMÉR: 103	
VERKHLUTI: Aðalteikningar Deili		ÚTGÁFA: A1	
Teiknað: Þórunn Sigþórsdóttir kt. 060874-3959		Bláðstaerð: A2	
Hönnuður: Björgvin Viglundsson kt. 040546-2009	Samþykkt: <i>Björgvin Viglundsson</i>	Dagsetning: 07/01/22	
Hönnunarstjóri: Björgvin Viglundsson kt. 040546-2009	Samþykkt: <i>Björgvin Viglundsson</i>	Frumútgáfa: 07/01/22	
LARSEN HÖNNUN OG RAÐGJÖF		Bent Larsen Fróðsson Byggingafræðingur B.Sc Sími 844-7699 tölvupóstur: bent@larsenhr.is	
VERKNR: 21-195		MKV: 1:20	

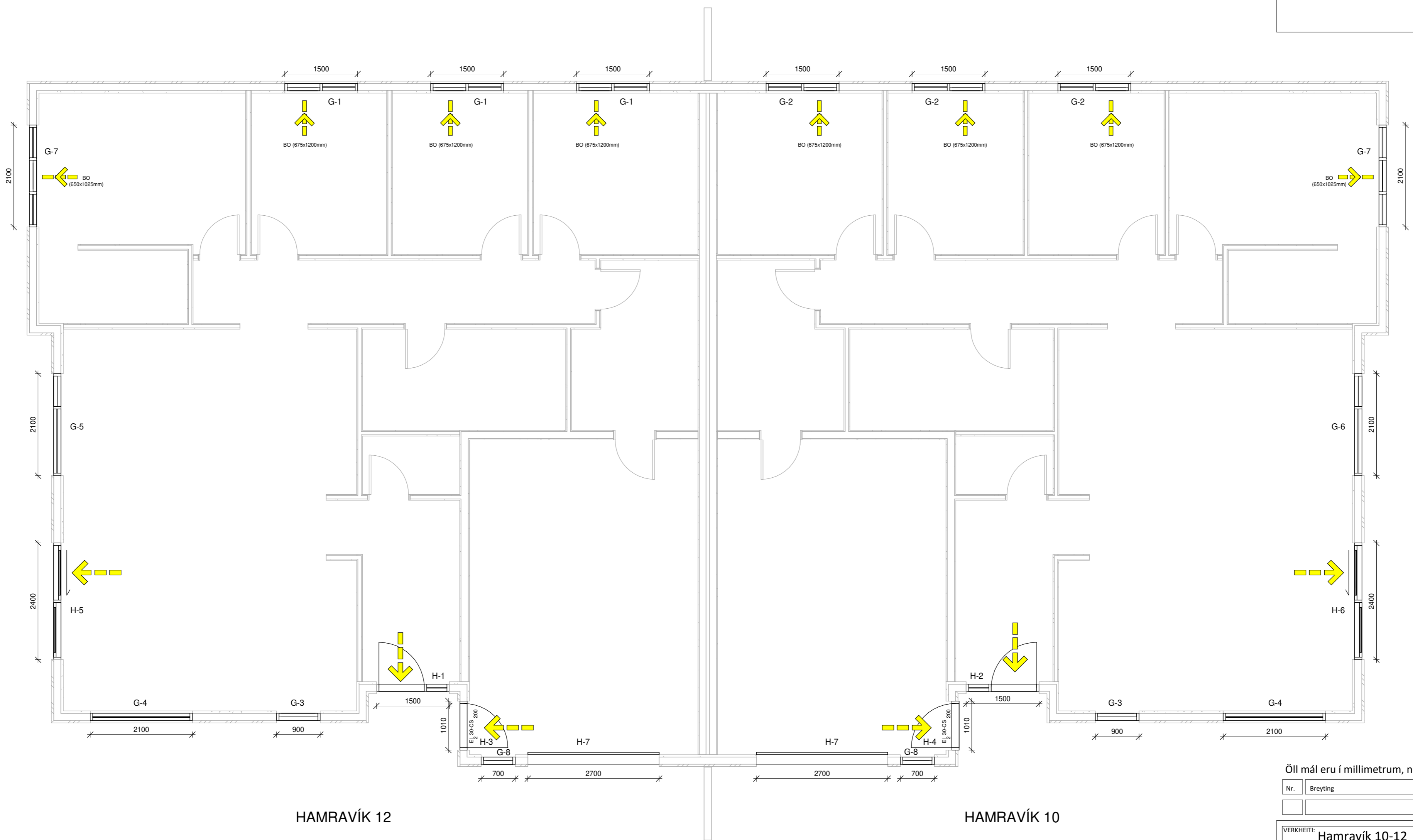

HAMRAVÍK 12

HAMRAVÍK 10

Öll mál eru í millimetrum, nema annað sé tekið fram.

Nr.	Breyting	Dagsetning	Yfirarið

VERKHEITI:	Hamravík 10-12 800 Selfoss	TEIKNINÚMÉR:	300
------------	-------------------------------	--------------	-----

VERKHLUTI:	Aðalteikningar Grunnmynd (gluggar og hurðir)	ÚTGÁFA:	A1
------------	---	---------	----

Teiknað:	Pórunn Sigþórsdóttir kt. 060874-3959	Blaðstærð:	A2
----------	--------------------------------------	------------	----

Hönnuður:	Björgvin Viglundsson kt. 040546-2009	Samþykkt:	<i>Björgvin Viglundsson</i>	Dagsetning:	07/01/22
-----------	--------------------------------------	-----------	-----------------------------	-------------	----------

Hönnunarstjóri:	Björgvin Viglundsson kt. 040546-2009	Samþykkt:	<i>Björgvin Viglundsson</i>	Frumútgáfa:	07/01/22
-----------------	--------------------------------------	-----------	-----------------------------	-------------	----------

LARSEN HÖNNUN OG RAÐGJÖF	Bent Larsen Fróðason Byggingrafæðingur B.Sc Sími 844-7699 tölvupóstur: bent@larsenhr.is	VERKNR:	21-195	MKV:	1:60
------------------------------------	--	---------	--------	------	------

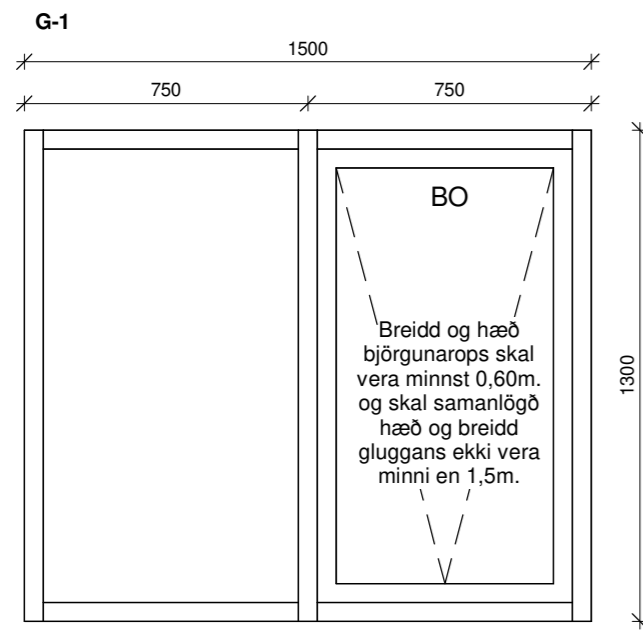

Gluggi 3 stk.

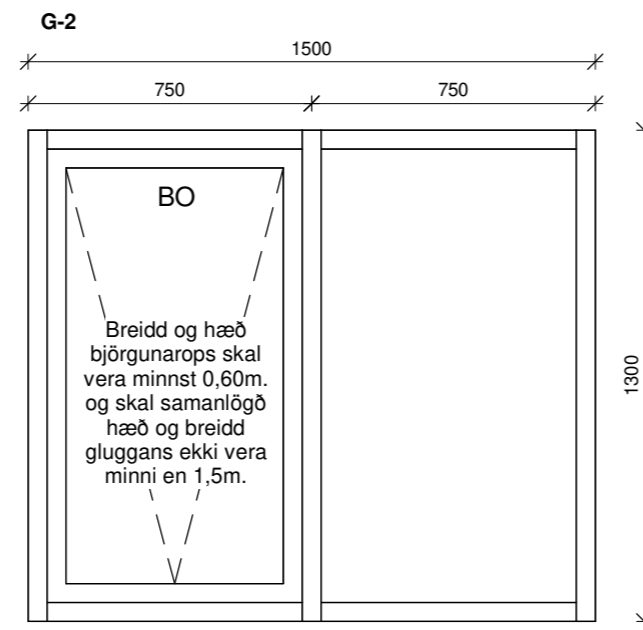

Gluggi 3 stk.

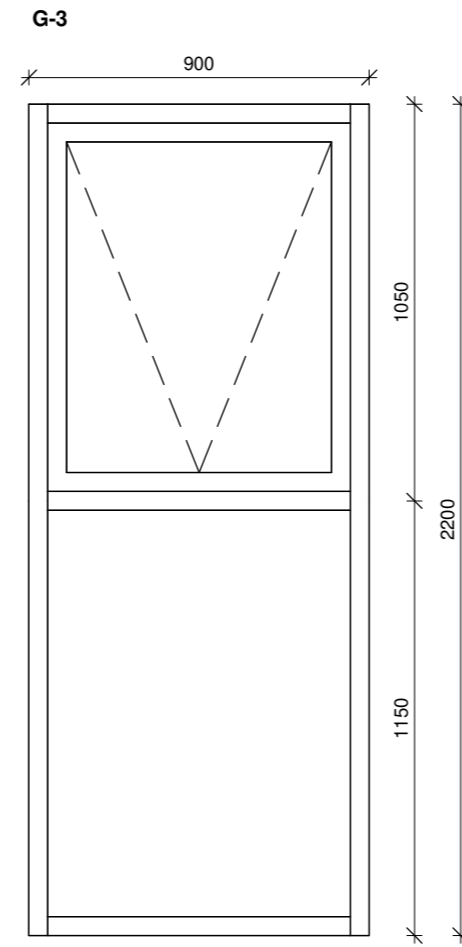

Gluggi 2 stk.

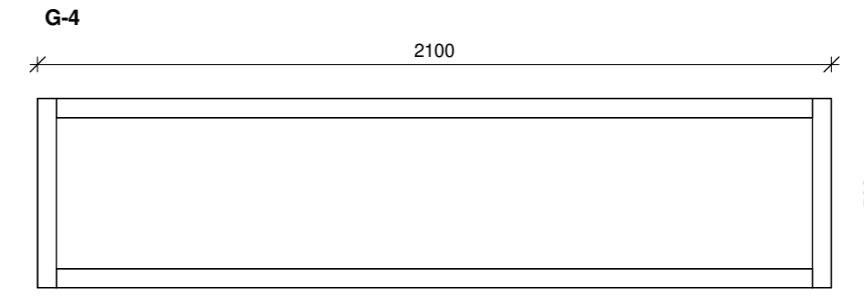

Gluggi 2 stk.

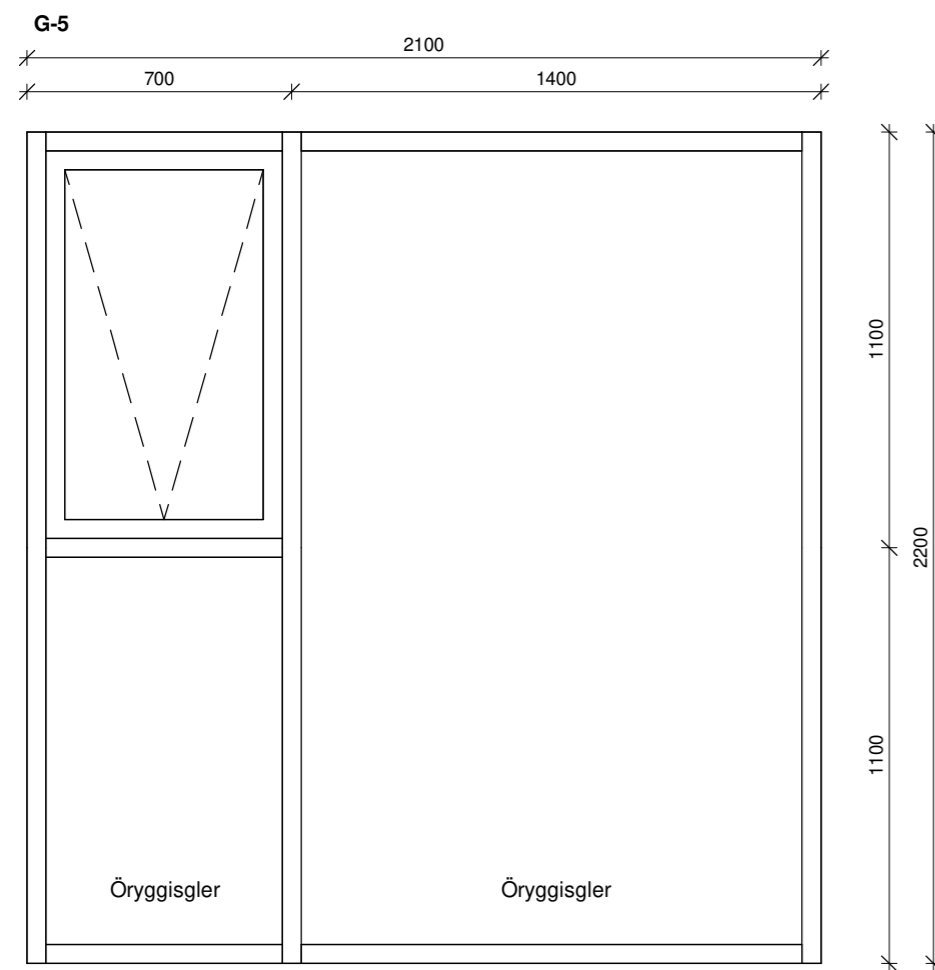

Gluggi 1 stk.

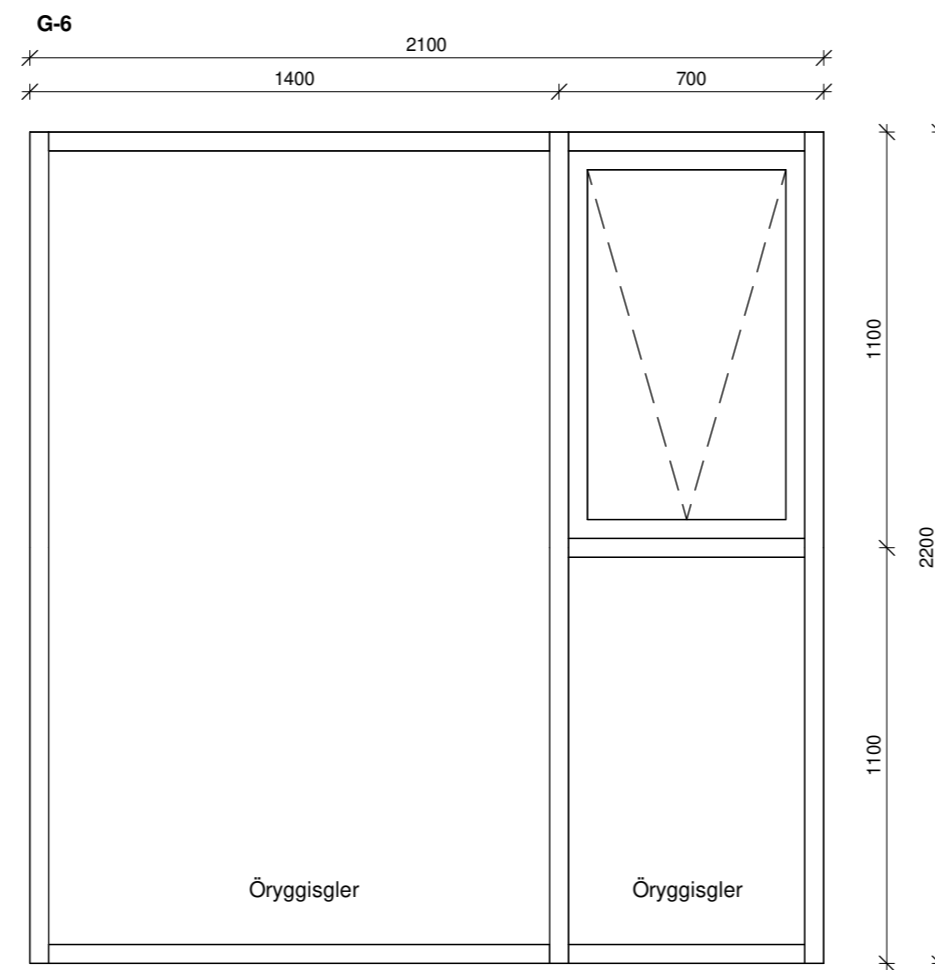

Gluggi 1 stk.

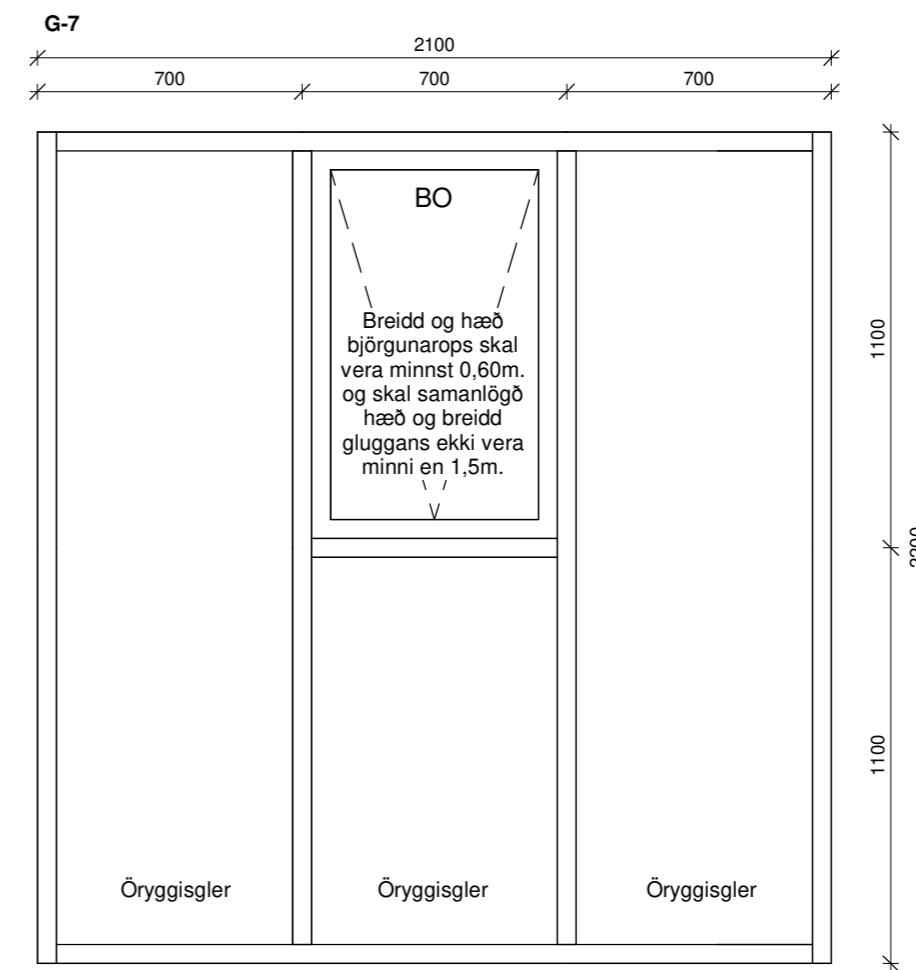

Gluggi 2 stk.

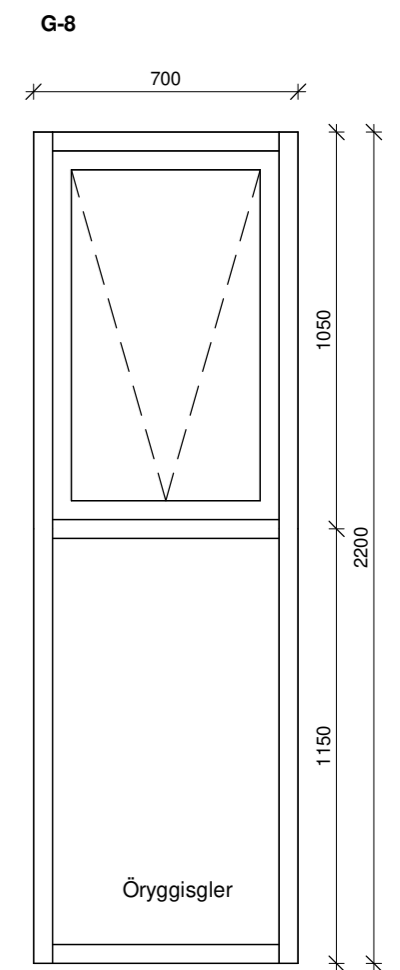

Gluggi 2 stk.

Öll mál eru í millimetrum, nema annað sé tekið fram.

Nr.	Breyting	Dagsetning	Yfirarið

VERKHEITI: Hamravík 10-12 800 Selfoss	TEIKNINÚMÉR: 301
VERKHLUTI: Aðalteikningar Útlit (gluggar)	ÚTGÁFA: A1
Teiknað: Pórunn Sigþórsdóttir kt. 060874-3959	Blaðstærð: A2
Hönnuður: Björgvin Viglundsson kt. 040546-2009	Samþykkt: <i>Björgvin Viglundsson</i>
Hönnunarskjóli: Björgvin Viglundsson kt. 040546-2009	Samþykkt: <i>Björgvin Viglundsson</i>
LARSEN HÖNNUN OG RAÐGJÖF	Bent Larsen Fróðason Byggingafræðingur B.Sc Sími 844-7699 tölvupóstur: bent@larsenhr.is
Blásetning: 07/01/22	Frumútgáfa: 07/01/22
VERKNR: 21-195	MKV: 1:20

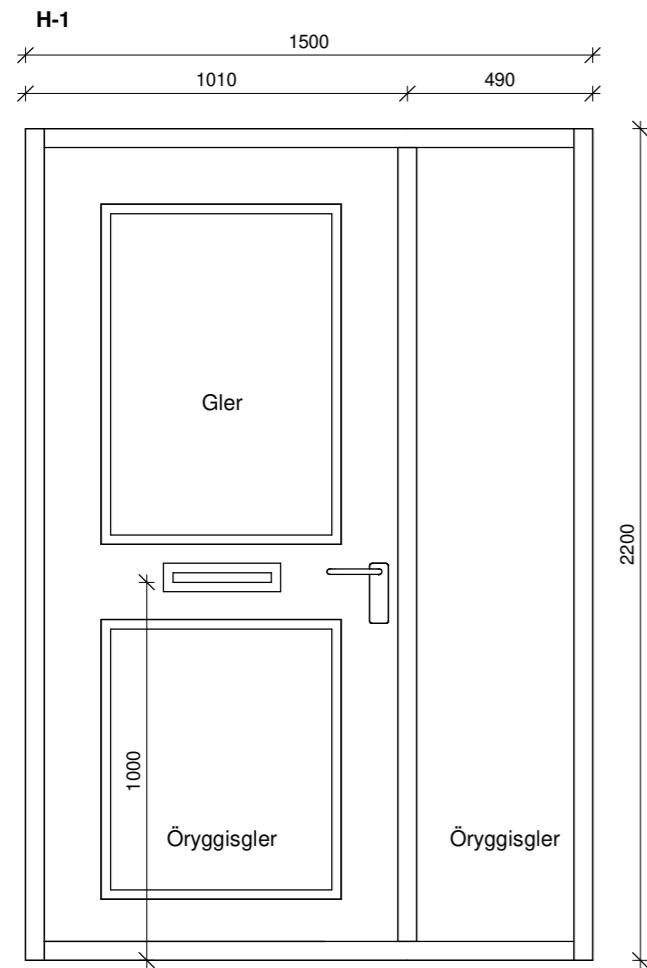

Inngangshurð 1 stk.
Hægri hurð, opnast inn

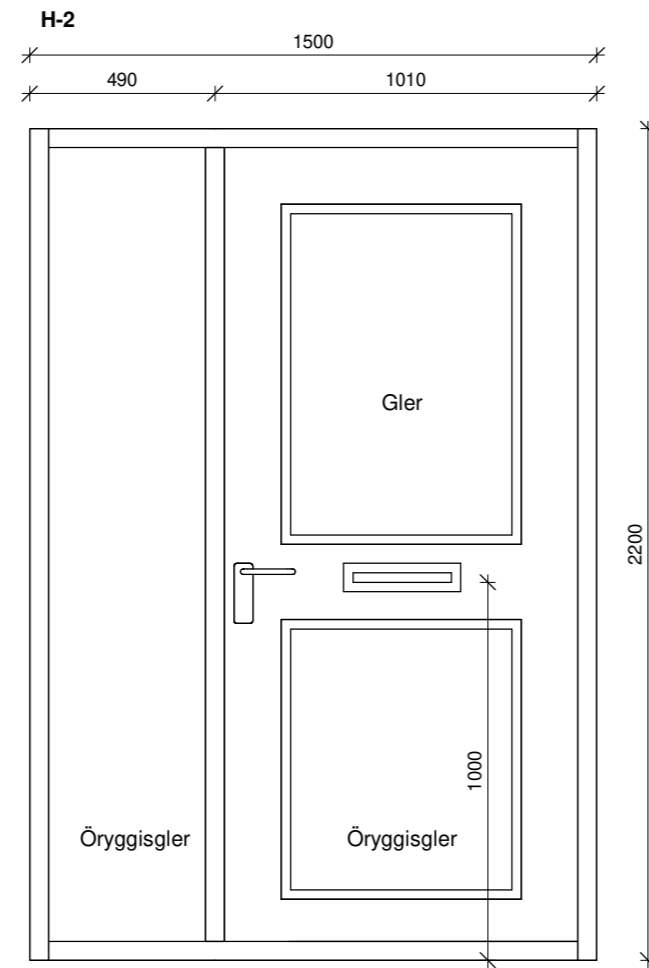

Inngangshurð 1 stk.
Vinstri hurð, opnast inn

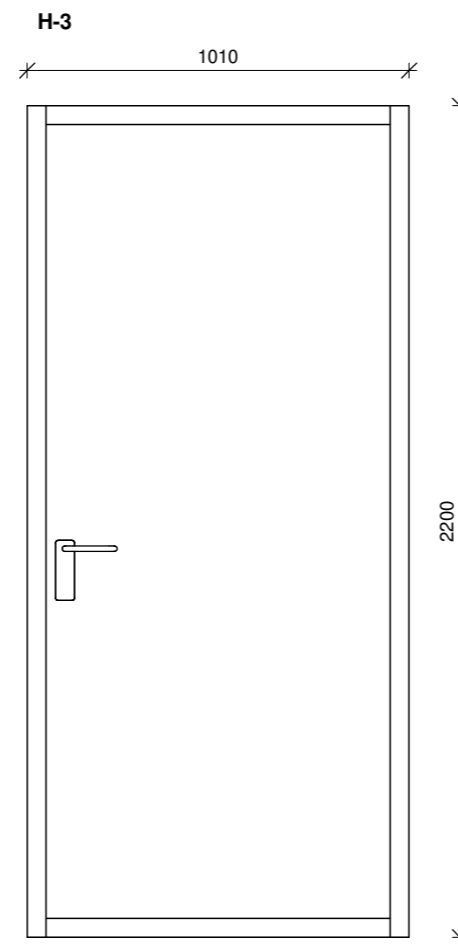

Hurð EI₂ 30-CS₂₀₀ 1 stk.
Vinstri hurð, opnast inn

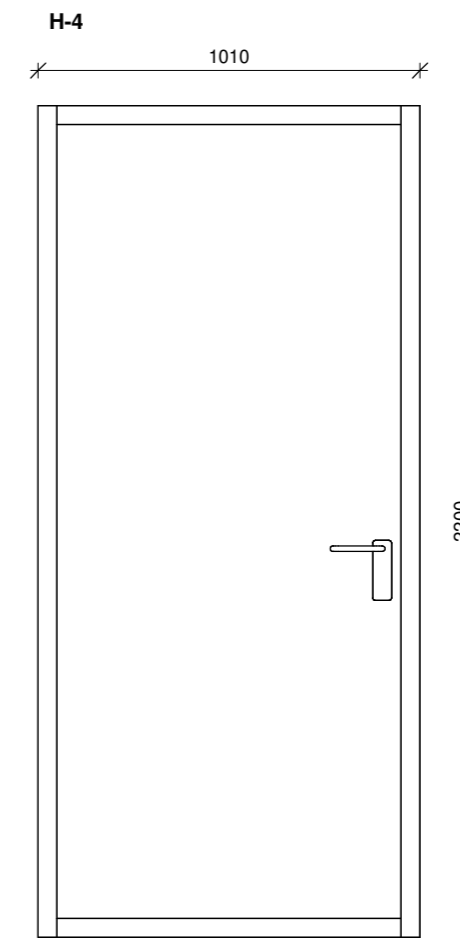

Hurð EI₂ 30-CS₂₀₀ 1 stk.
Hægri hurð, opnast inn

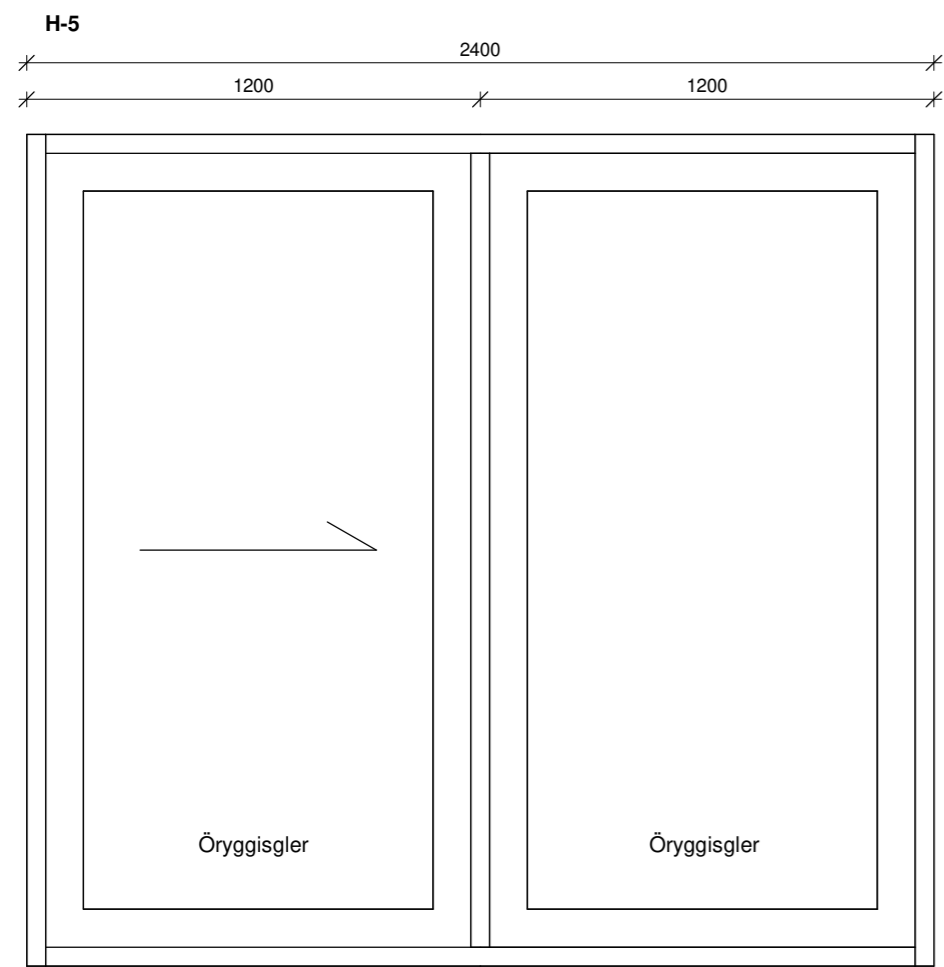

Rennihurð 1 stk.
Hægri fleki opnast til vinstri (séð innan frá)

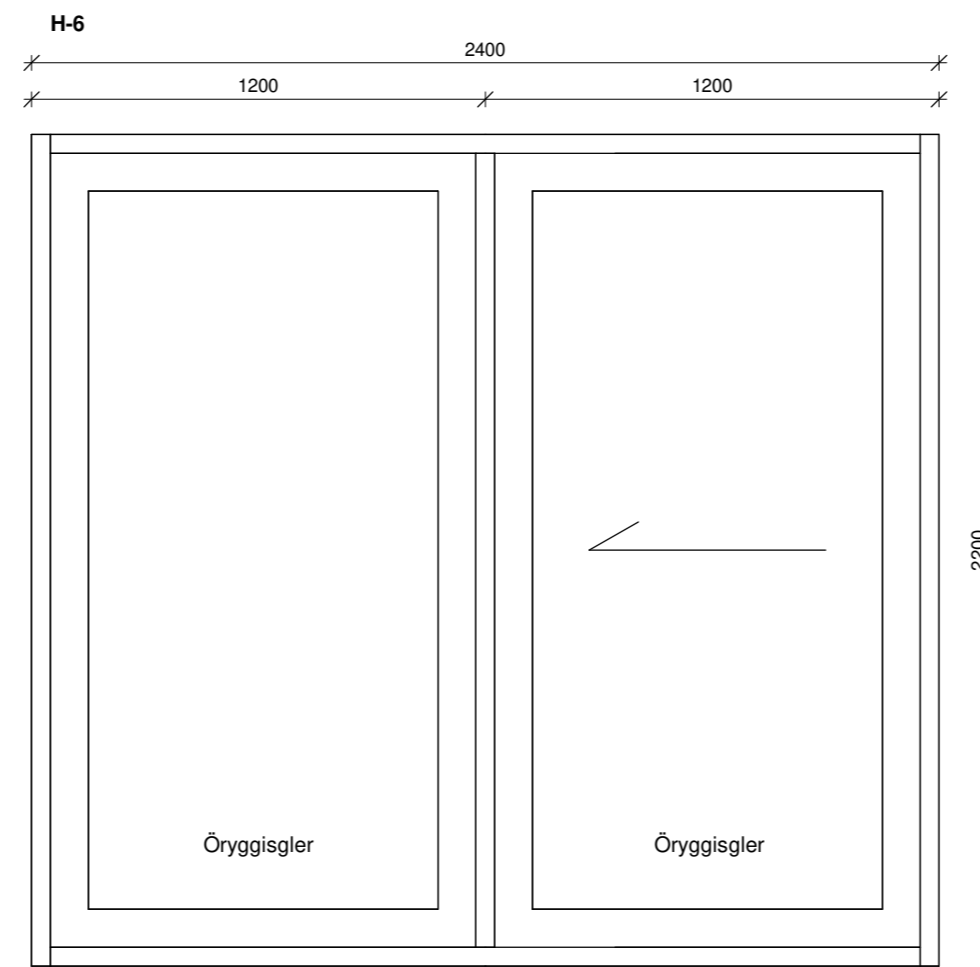

Rennihurð 1 stk.
Vinstri fleki opnast til hægri (séð innan frá)

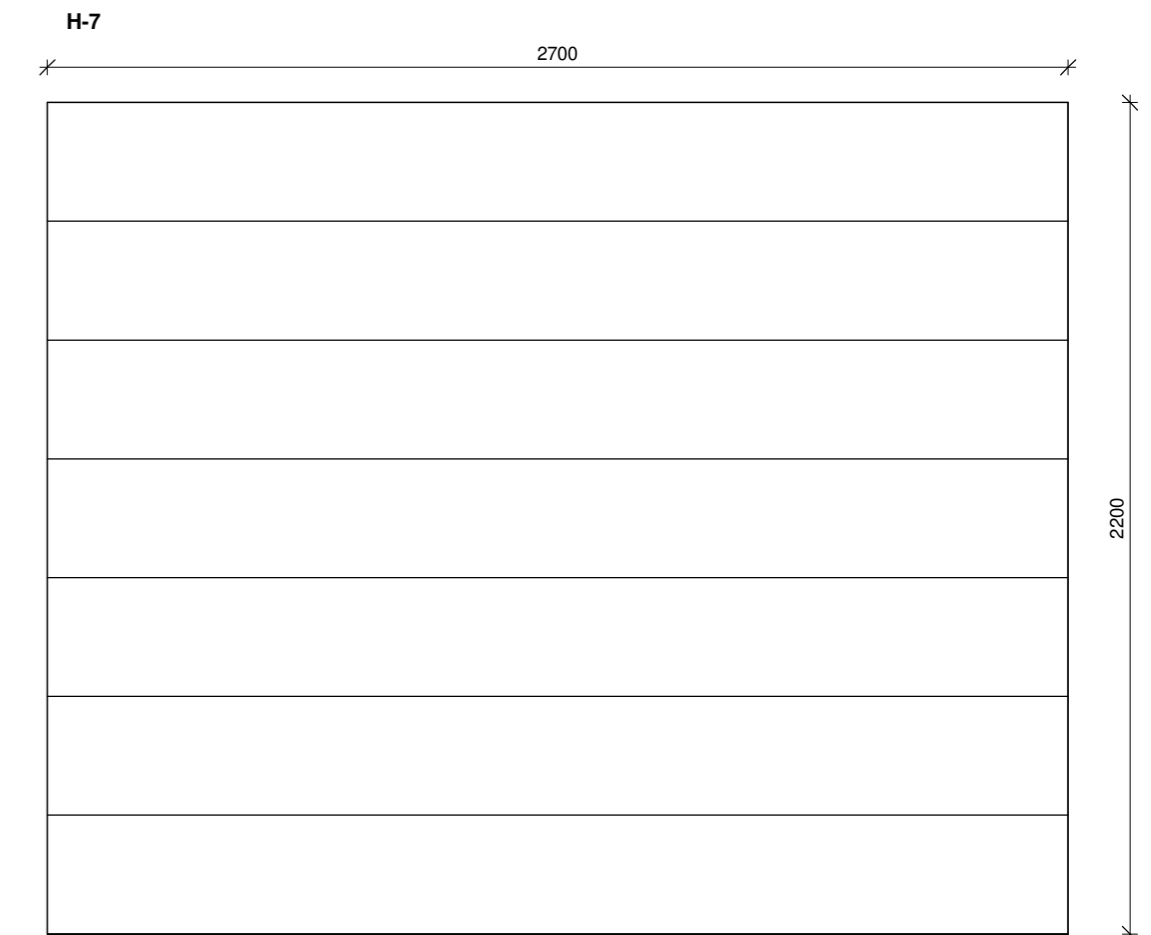

Bílskúrshurð 2 stk.

Öll mál eru í millimetrum, nema annað sé tekið fram.

Nr.	Breyting	Dagsetning	Yfirarið

VERKHEITI: Hamravík 10-12 800 Selfoss	TEIKNINÚMÉR: 302
VERKHLUTI: Aðaltekningar Útlit (hurðir)	ÚTGÁFA: A1
Teiknað: Pórunn Sigþórsdóttir kt. 060874-3959	Blaðstærð: A2
Hönnuður: Björgvin Viglundsson kt. 040546-2009	Samþykkt: <i>Björgvin Viglundsson</i>
Hönnunarskjóli: Björgvin Viglundsson kt. 040546-2009	Samþykkt: <i>Björgvin Viglundsson</i>
LARSEN HÖNNUN OG RAÐGJÖF	Bent Larsen Fróðason Byggingafræðingur B.Sc Sími 844-7699 tölvupóstur: bent@larsenhr.is
VERKNR: 21-195	MKV: 1:20
Dagsetning: 07/01/22	Frumútgáfa: 07/01/22