

# SVEITARFÉLAGIÐ ÁRBORG

Suðurhólar  
maí 2021  
TEIKNINGAHEFTI  
2836-046



YFIRLITSMYND

**Suðurhólar 2021 - Teikningaskrá**

2839-046-03

 Teikningaskrá síðast breytt dags: **21.5.2021**

EFLA teikn. nr.	Heiti teikningar	Mkv. (A1)	Í gildi		Síðasta útgáfa		aths
			Útgáfa nr.	dags.	Útgáfa nr.	dags	
A101	Forsíða						
A102	Teikningaskrá		Ú	21.05.21			
C101	Suðurhólar, grunnmynd og langsníð	1:1000	Ú	14.05.21			
F101	Kennisnið	án kvarða	Ú	14.05.21			
400	Hitaveita - grunnmynd	1:250	Ú	14.05.21			
401	Hitaveita - lekavakt	1:250	Ú	14.05.21			
420	Hitaveita - Skýringar, lekavakt og tæmibrunnur	án kvarða	Ú	14.05.21			
421	Hitaveita - Skýringar, frauðplötur og lokar	án kvarða	Ú	14.05.21			
430	Fjarskipti, grunnmynd	1:500	Ú	14.05.21			
500	Götulýsing - grunnmynd og kennisnið	1:1000	Ú	14.05.21			

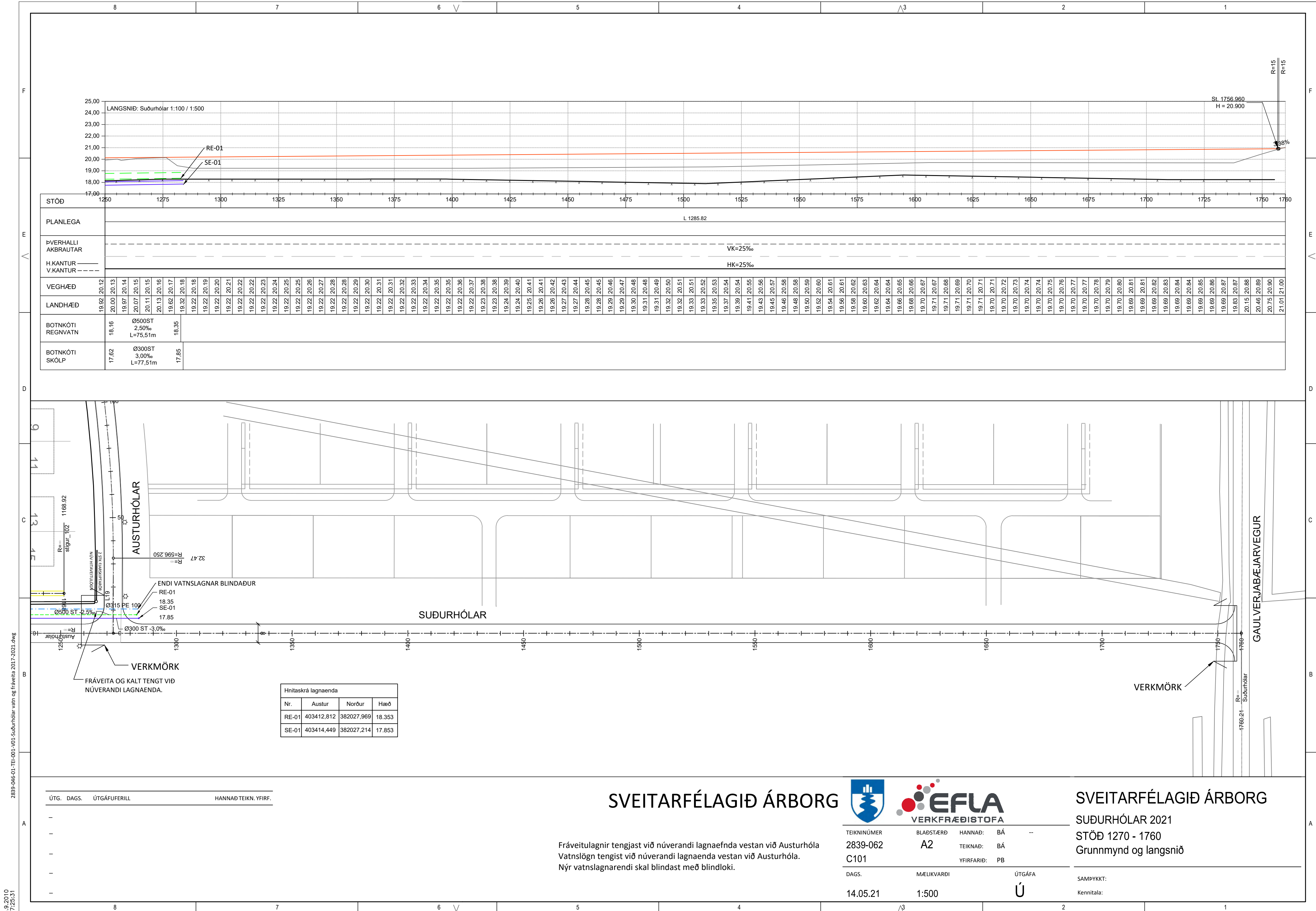

STÖÐ	1250	1275	1300	1325	1350	1375	1400	1425	1450	1475	1500	1525	1550	1575	1600	1625	1650	1675	1700	1725	1750	1750	1760																																																																																																																																																																										
PLANLEGA	L 1285.82																																																																																																																																																																																																
ÞVERHALLI AKBRAUTAR	VK=25‰																																																																																																																																																																																																
H.KANTUR	HK=25‰																																																																																																																																																																																																
V.KANTUR																																																																																																																																																																																																	
VEGHÆÐ	19.92	20.12	20.13	20.14	20.15	20.16	20.17	20.18	20.18	20.19	20.20	20.21	20.22	20.22	20.23	20.24	20.25	20.25	20.26	20.27	20.28	20.28	20.29	20.30	20.31	20.31	20.32	20.33	20.34	20.35	20.35	20.36	20.37	20.38	20.38	20.39	20.40	20.41	20.41	20.42	20.43	20.44	20.45	20.45	20.46	20.47	20.48	20.48	20.49	20.50	20.51	20.51	20.52	20.53	20.54	20.55	20.56	20.57	20.58	20.58	20.59	20.60	20.61	20.62	20.63	20.64	20.64	20.65	20.66	20.67	20.68	20.69	20.70	20.71	20.71	20.72	20.73	20.74	20.75	20.76	20.77	20.78	20.79	20.80	20.81	20.82	20.83	20.84	20.85	20.86	20.87	20.88	20.89	20.90	21.01	21.00																																																																																																	
LANDHÆÐ	19.92	20.00	20.13	19.97	20.14	20.07	20.15	20.11	20.16	20.13	20.16	19.62	20.17	19.32	20.18	19.22	20.18	19.22	20.19	19.22	20.20	19.22	20.21	19.22	20.22	19.22	20.22	19.22	20.23	19.22	20.24	19.22	20.25	19.22	20.25	19.22	20.26	19.22	20.27	19.22	20.28	19.22	20.28	19.22	20.29	19.22	20.29	19.22	20.30	19.22	20.31	19.22	20.31	19.22	20.32	19.22	20.33	19.22	20.34	19.22	20.35	19.22	20.35	19.22	20.36	19.22	20.37	19.22	20.38	19.22	20.38	19.22	20.39	19.22	20.40	19.22	20.41	19.22	20.41	19.22	20.42	19.22	20.43	19.22	20.44	19.22	20.45	19.22	20.45	19.22	20.46	19.22	20.47	19.22	20.48	19.22	20.48	19.22	20.49	19.22	20.50	19.22	20.51	19.22	20.51	19.22	20.52	19.22	20.53	19.22	20.54	19.22	20.55	19.22	20.56	19.22	20.57	19.22	20.58	19.22	20.58	19.22	20.59	19.22	20.60	19.22	20.61	19.22	20.62	19.22	20.63	19.22	20.64	19.22	20.64	19.22	20.65	19.22	20.66	19.22	20.67	19.22	20.68	19.22	20.69	19.22	20.70	19.22	20.71	19.22	20.71	19.22	20.72	19.22	20.73	19.22	20.74	19.22	20.75	19.22	20.76	19.22	20.77	19.22	20.78	19.22	20.79	19.22	20.80	19.22	20.81	19.22	20.82	19.22	20.83	19.22	20.84	19.22	20.85	19.22	20.86	19.22	20.87	19.22	20.88	19.22	20.89	19.22	20.90	19.22	21.01	19.22	21.00
BOTNKÓTI REGNVATN	18.16	20.00	Ø500ST 2.50‰ L=75,51m	18.35																																																																																																																																																																																													
BOTNKÓTI SKÓLP	17.62	Ø300ST 3.00‰ L=77,51m	17.85																																																																																																																																																																																														

Hnitaskrá lagnaenda			
Nr.	Austur	Norður	Hæð
RE-01	403412,812	382027,969	18.353
SE-01	403414,449	382027,214	17.853

2839-046-01-TEI-001-V01-Suðurhólar vatn og fráveita 2017-2021.dwg

6.9.2010  
17:25:31

SVEITARFÉLAGIÐ ÁRBORG



SVEITARFÉLAGIÐ ÁRBORG

Fráveitulagnir tengjast við núverandi lagnaefnda vestan við Austurhóla  
Vatnslögn tengist við núverandi lagnaenda vestan við Austurhóla.  
Nýr vatnslagnarendi skal blindast með blindloki.

TEIKNINÚMÉR	BLADSTÆRD	HANNAD:	BÁ
2839-062	A2	TEIKNAD:	BÁ
C101		YFIRFARID:	PB
DAGS.	MÆLIKVARDI	ÚTGÁFA	
14.05.21	1:500	Ú	

SUÐURHÓLAR 2021  
STÖÐ 1270 - 1760  
Grunnmynd og langsníð

SAMPYKKT:  
Kennitala:

2839-046-01-TEI-002-V01-Sáfræsi- Suðurhólar 2017-2021 - Kennisnið.dwg  
6.9.2010 17:25:31

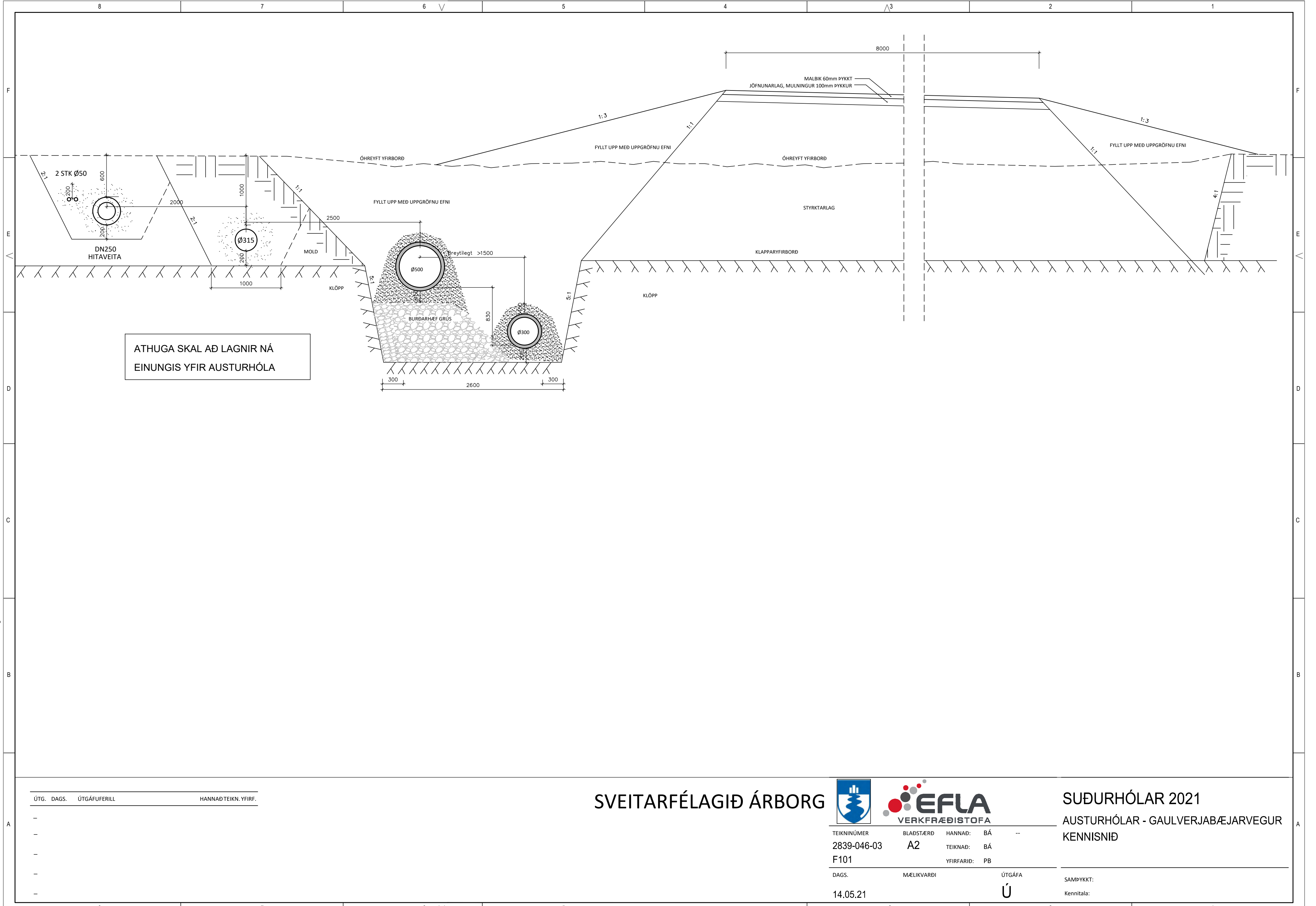

ATHUGA SKAL AÐ LAGNIR NÁ  
EINUNGIS YFIR AUSTURHÓLA

ÚTG.	DAGS.	ÚTGÁFUERILL	HANNAÐ TEIKN. YFIRF.
-	-	-	-
-	-	-	-
-	-	-	-
-	-	-	-
-	-	-	-

SVEITARFÉLAGIÐ ÁRBORG



SUÐURHÓLAR 2021  
AUSTURHÓLAR - GAULVERJABÆJARVEGUR  
KENNISNIÐ

TEIKNINÚMÉR	BLAÐSTÆRD	HANNAÐ:	BÁ	--
2839-046-03	A2	TEIKNAD:	BÁ	
F101		YFIRFARIÐ:	PB	
DAGS.	MÆLIKVARÐI	ÚTGÁFA		
14.05.21		Ú		

SAMPYKKT:  
Kennitala:



20.5.2021 15:52:35 O:\Arbörg\_2839\046\_Austurbýggð - Frágangur\01\_Hönnun\09 Teikningar\2839-046-01-TEI-005-V01-Suðurbólur hitaveita 2021.dwg

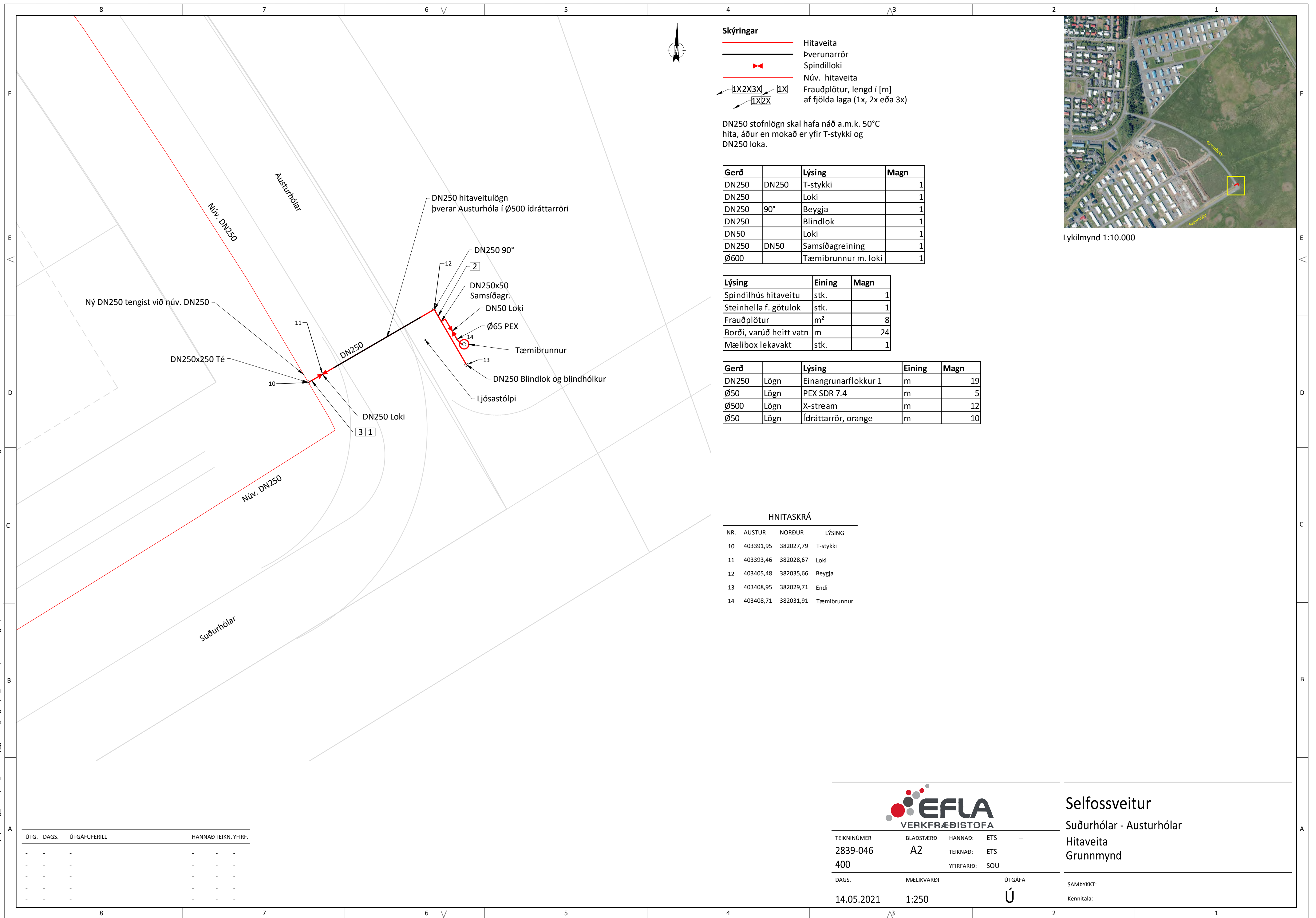

**Skýringar**

<span style="color: red;">—</span>	Hitaveita
—	pverunarrör
✂	Spindilloki
—	Núv. hitaveita
↔	Frauðplötur, lengd í [m]
↔	af fjölda laga (1x, 2x eða 3x)

DN250 stofnlögn skal hafa náð a.m.k. 50°C hita, áður en mokað er yfir T-stykki og DN250 loka.

Gerð	Lýsing	Magn
DN250	DN250 T-stykki	1
DN250	Loki	1
DN250	90° Beygja	1
DN250	Blindlok	1
DN50	Loki	1
DN250	DN50 Samsíðagreining	1
Ø600	Tæmibrunnur m. loki	1

Lýsing	Eining	Magn
Spindilhús hitaveitu	stk.	1
Steinhella f. götulok	stk.	1
Frauðplötur	m <sup>2</sup>	8
Borði, varúð heitt vatn	m	24
Mælibox lekavakt	stk.	1

Gerð	Lýsing	Eining	Magn
DN250	Lögn Einangrunarflokkur 1	m	19
Ø50	Lögn PEX SDR 7.4	m	5
Ø500	Lögn X-stream	m	12
Ø50	Lögn Ídráttarrör, orange	m	10

**HNITASKRÁ**

NR.	AUSTUR	NORÐUR	LÝSING
10	403391,95	382027,79	T-stykki
11	403393,46	382028,67	Loki
12	403405,48	382035,66	Beygja
13	403408,95	382029,71	Endi
14	403408,71	382031,91	Tæmibrunnur



Lykilmynd 1:10.000

ÚTG.	DAGS.	ÚTGÁFUERILL	HANNAÐ TEIKN. YFIRF.
-	-	-	-
-	-	-	-
-	-	-	-
-	-	-	-
-	-	-	-



TEIKNINÚMÉR	BLADSTÆRD	HANNAÐ:	ETS	--
2839-046	A2	TEIKNAD:	ETS	
400		YFIRFARID:	SQU	
DAGS.	MÆLIKVARÐI	ÚTGÁFA		
14.05.2021	1:250	Ú		

**Selfossveitur**  
Suðurbólur - Austurbólur  
Hitaveita  
Grunnmynd

SAMPYKKT:  
Kennitala:

20.5.2021 17:02:37 O:\Arbörg\_2839\046\_Austurborg - Frágangur\01\_Hönnun\09 Teikningar\2839-046-01-TEI-005-V01-Suðurborgar hitaveita 2021.dwg

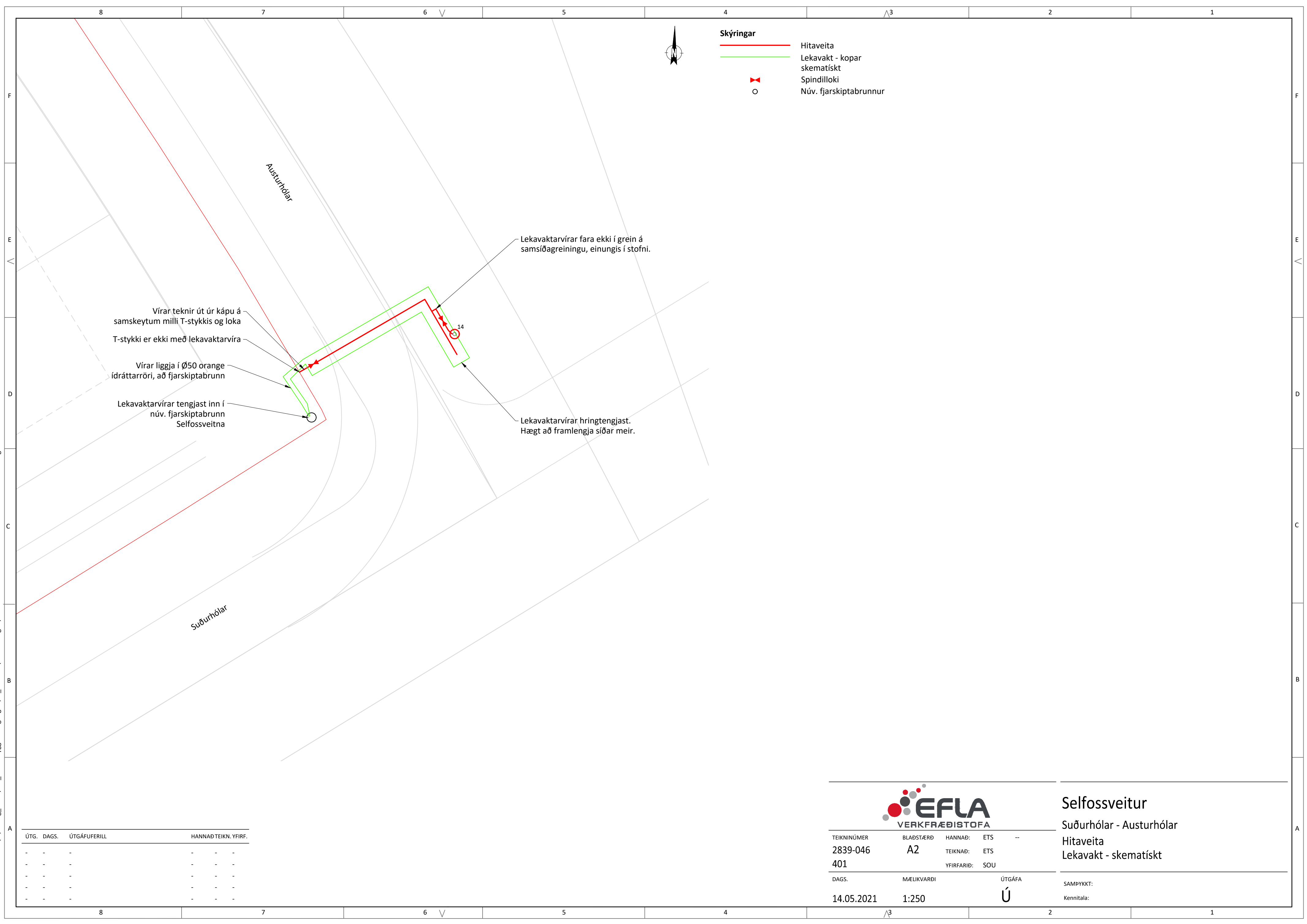

- Skýringar**
- Hitaveita
  - Lekavakt - kopar skematískt
  - Spindilloki
  - Núv. fjarskiptabrunnur

Vírar teknir út úr kápu á samskeytum milli T-stykkis og loka  
T-stykki er ekki með lekavaktarvíra

Vírar liggja í Ø50 orange ídráttarröri, að fjarskiptabrunn

Lekavaktarvírar tengjast inn í núv. fjarskiptabrunn Selfossveitna

Lekavaktarvírar fara ekki í grein á samsíðagreiningu, einungis í stofni.

Lekavaktarvírar hringtengjast. Hægt að framlengja síðar meir.

ÚTG.	DAGS.	ÚTGÁFUERILL	HANNAÐ	TEIKN.	YFIRF.
-	-	-	-	-	-
-	-	-	-	-	-
-	-	-	-	-	-
-	-	-	-	-	-
-	-	-	-	-	-



**Selfossveitur**  
Suðurborgar - Austurborgar  
Hitaveita  
Lekavakt - skematískt

TEIKNINÚMÉR	BLADSTÆRD	HANNAÐ:	ETS	--
2839-046	A2	TEIKNAD:	ETS	
401		YFIRFARID:	SQU	
DAGS.	MÆLIKVARÐI	ÚTGÁFA		
14.05.2021	1:250	Ú		

SAMPYKKT:  
Kennitala:

FRÁGANGUR FRAUÐPLATNA -

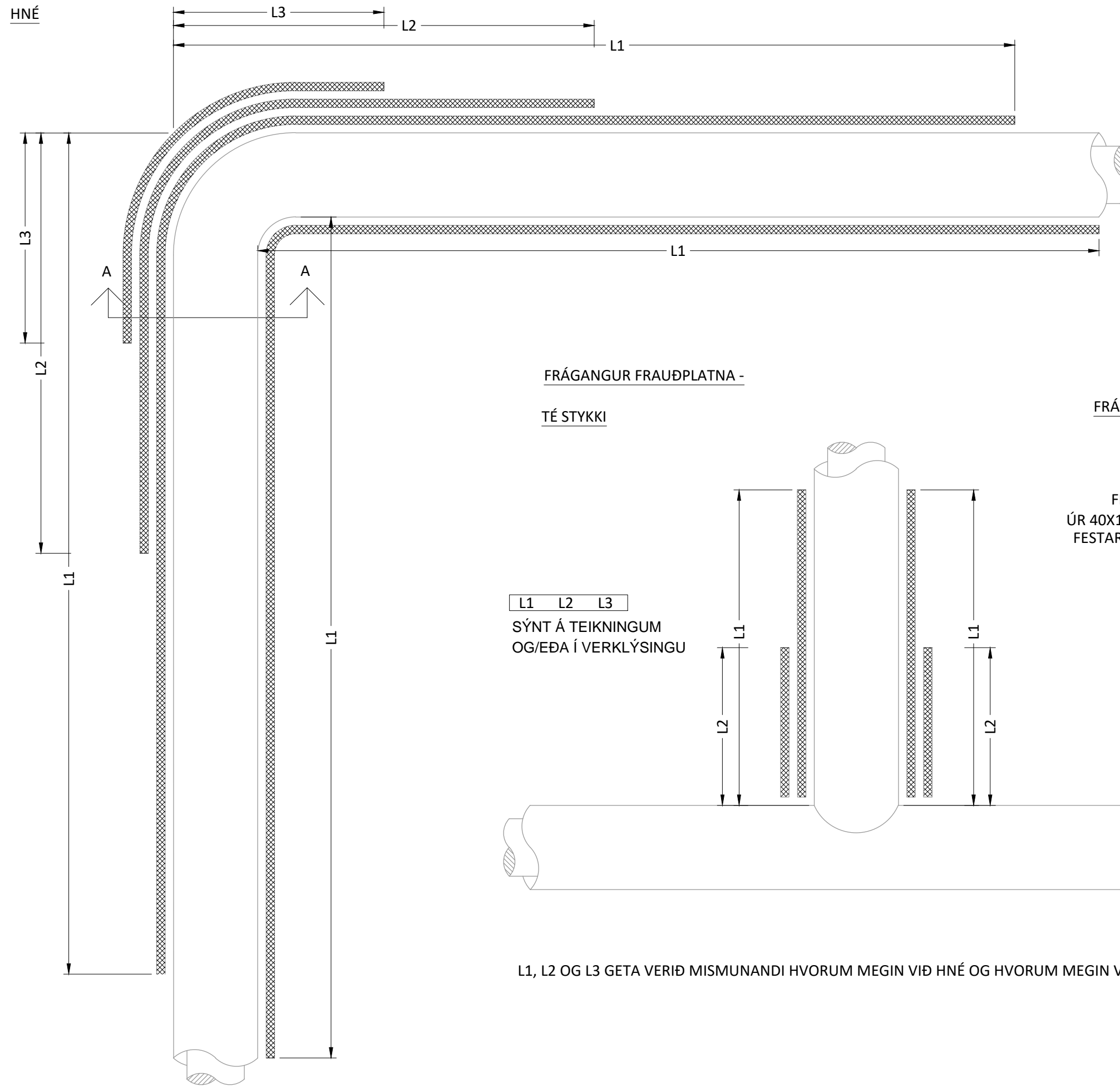

FRÁGANGUR FRAUÐPLATNA -

TÉ STYKKI

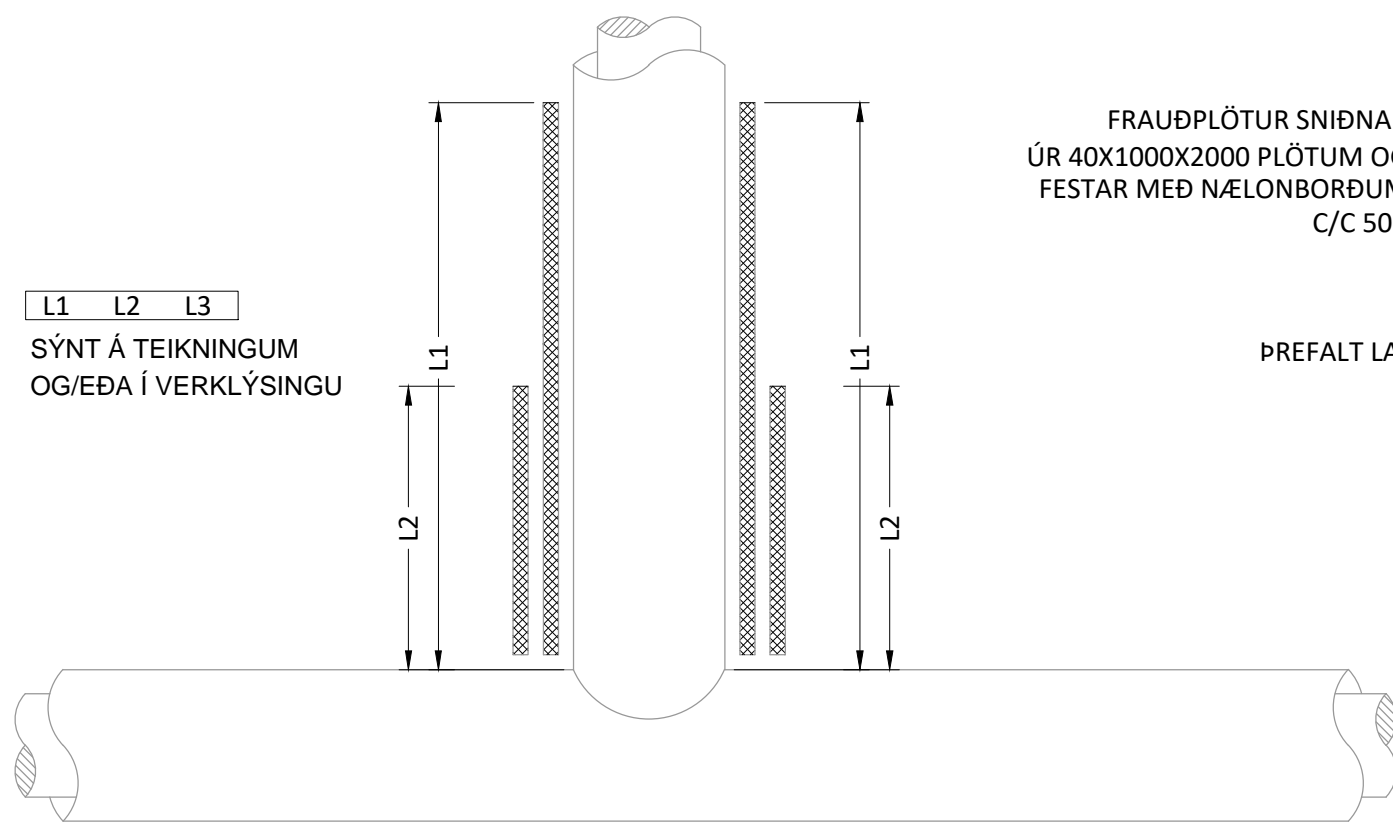

L1 L2 L3  
SÝNT Á TEIKNINGUM  
OG/EDA Í VERKLÝSINGU

FRÁGANGUR FRAUÐPLATNA - SNID A

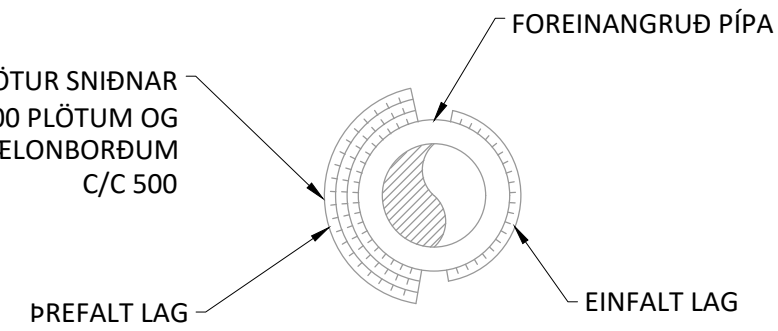

FRAUÐPLÖTUR SNIDNAR  
ÚR 40X1000X2000 PLÖTUM OG  
FESTAR MEÐ NÆLONBORÐUM  
C/C 500

L1, L2 OG L3 GETA VERIÐ MISMUNANDI HVORUM MEGIN VIÐ HNE OG HVORUM MEGIN VIÐ TÉ STYKKI

Frágangur á samskeytum, krumphólkar

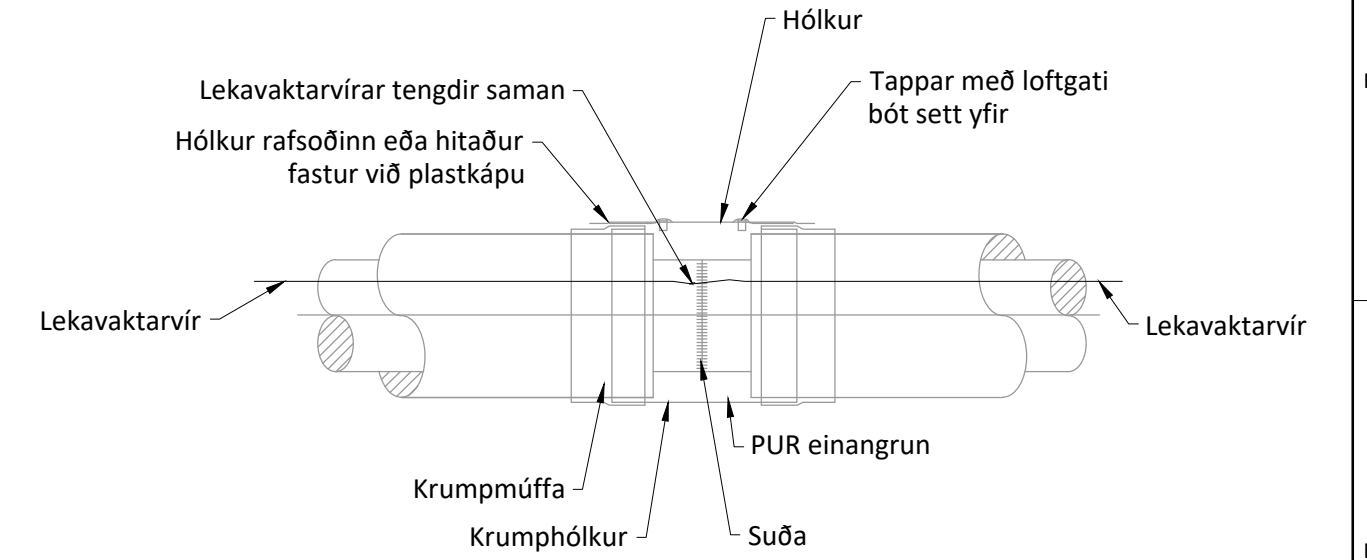

Jarðloki, grunnmynd

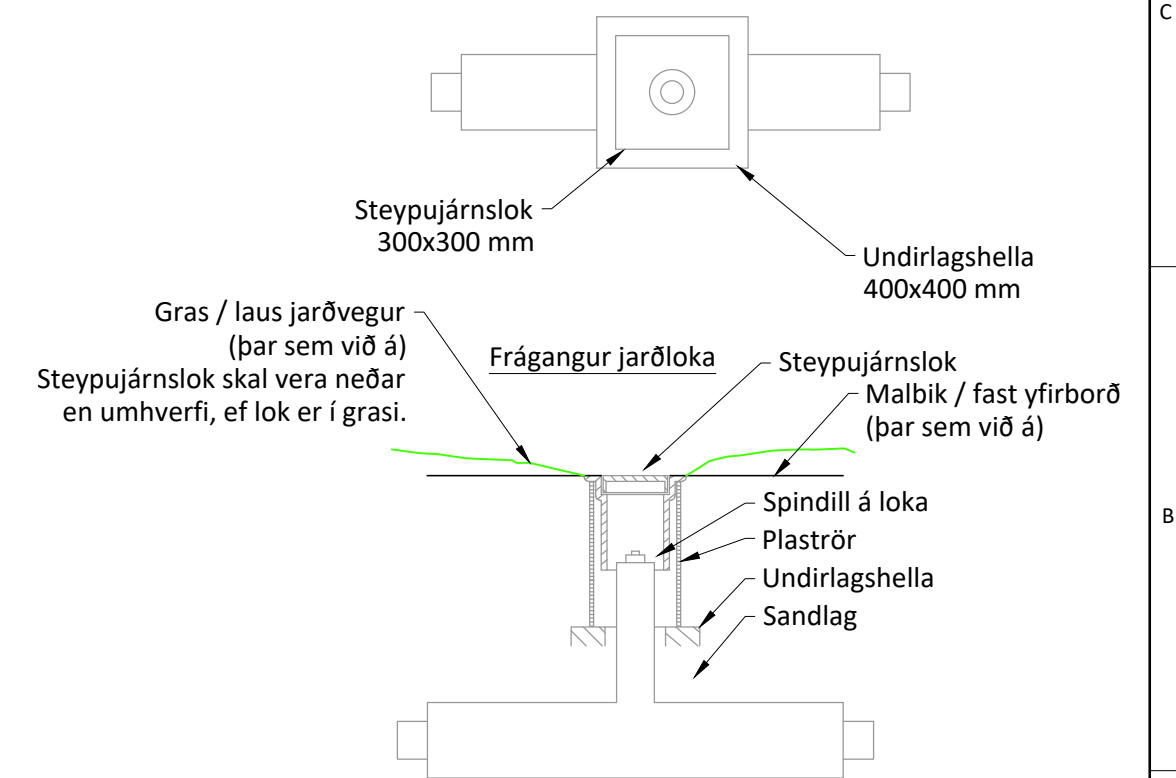

TEIKNINÚMÉR: 2839-046  
BLADSTÆRD: A2  
HANNAD: --  
TEIKNAD: ETS  
YFIRFARIÐ: SOU  
DAGS: 14.05.2021  
MÆLIKVARÐI: án kvarða  
ÚTGÁFA: Ú

Selfossveitur

Suðurhólar - Austurhólar  
Skýringar  
Frauðplötur, samskeyti, lokar

SAMPYKKT:  
Kennitala:



20.5.2021 17:01:11 O:\ArbOrg\_2839\046\_Austurbýggð - Frágangur\01\_Hönnun\09 Teikningar\2839-046-01-TEI-007-V01-Suðurbólur hitaveita skýringar.dwg

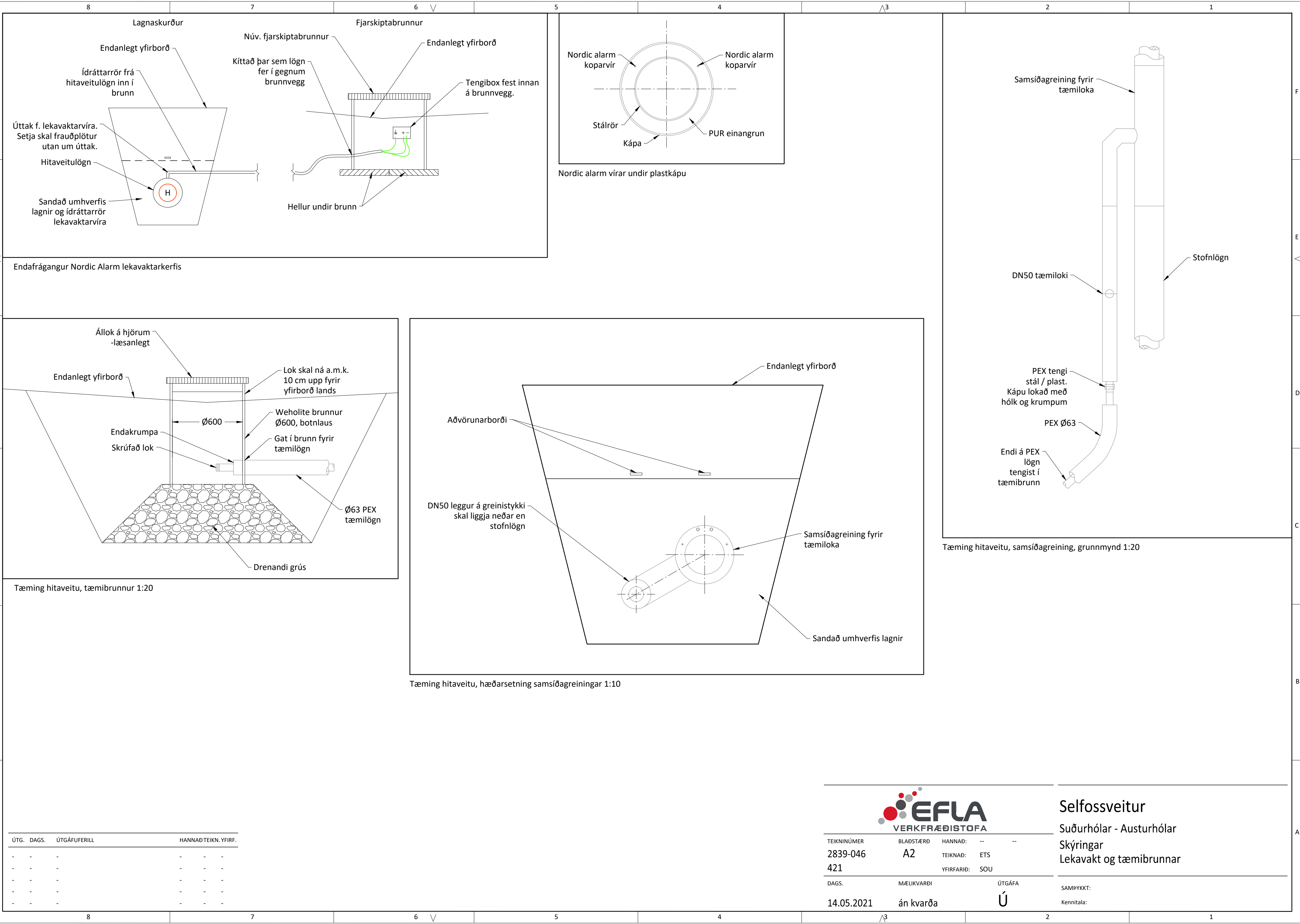

Endafrágangur Nordic Alarm lekavaktarkerfis

Tæming hitaveitu, tæmibrunnur 1:20

Tæming hitaveitu, hæðarsetning samsíðgreiningar 1:10

Tæming hitaveitu, samsíðgreining, grunnmynd 1:20

ÚTG.	DAGS.	ÚTGÁFUFRILL	HANNAÐ TEIKN. YFIRF.
-	-	-	-
-	-	-	-
-	-	-	-
-	-	-	-
-	-	-	-

TEIKNINÚMÉR: 2839-046  
421

DAGS: 14.05.2021

BLADSTÆRD: A2

MÆLIKVARÐI: án kvarða

HANNAÐ: --

TEIKNAD: ETS

YFIRFARID: SOU

ÚTGÁFA: Ú

SAMPYKKT: Kennitala:

**Selfossveitur**  
Suðurbólur - Austurbólur  
Skýringar  
Lekavakt og tæmibrunnar



O:\Arbörg\_2839\046\_Austurbýggð - Frágangur\01\_Hönnun\09\_Teikningar\2839-046-01-TEI-005-V01-Suðurhólar hitaveita 2021.dwg

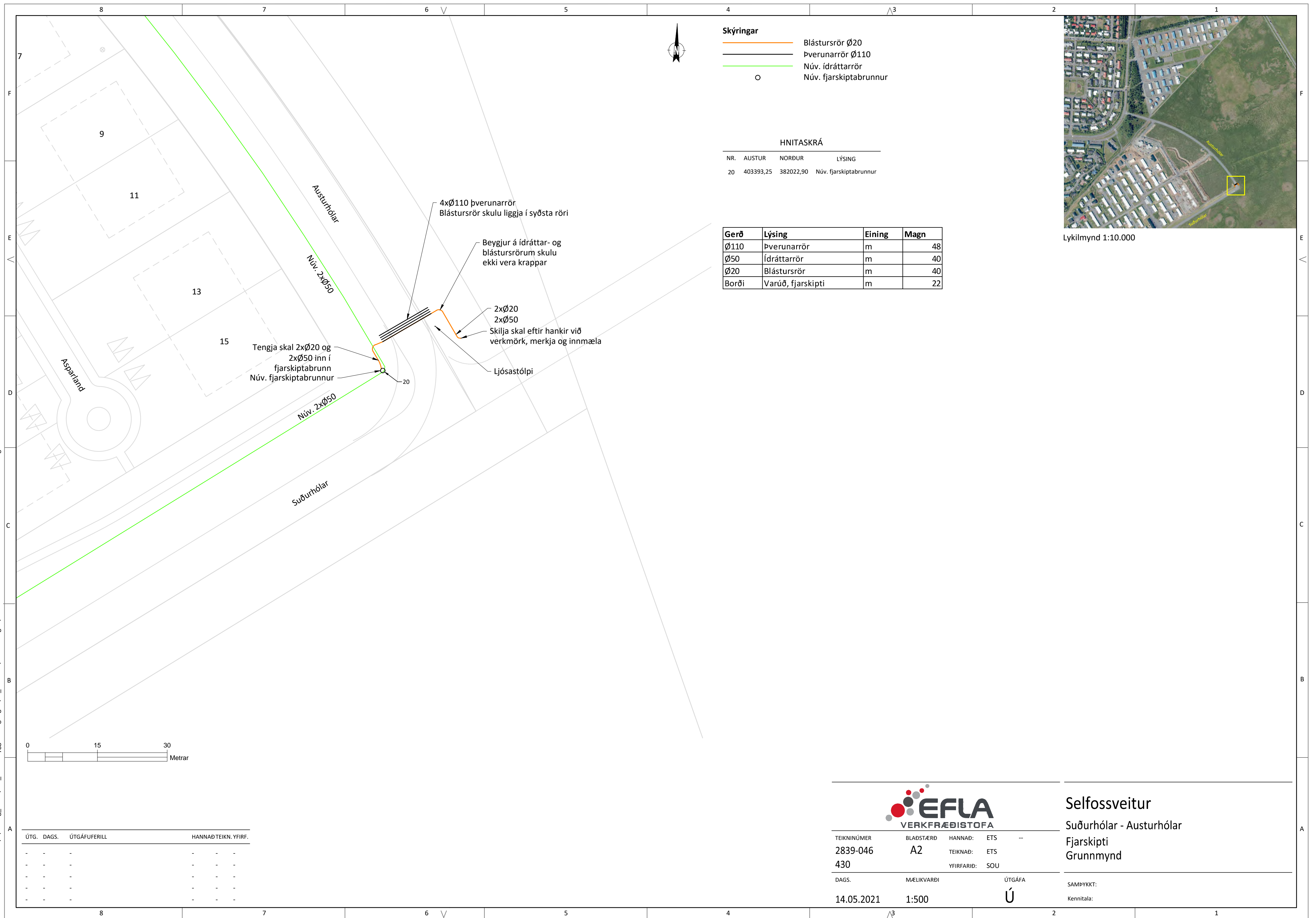

- Skýringar**
- Blástursrör Ø20
  - Þverunarrör Ø110
  - Núv. ídráttarrör
  - Núv. fjarskiptabrunnur

**HNITASKRÁ**

NR.	AUSTUR	NORDUR	LÝSING
20	403393,25	382022,90	Núv. fjarskiptabrunnur

Gerð	Lýsing	Eining	Magn
Ø110	Þverunarrör	m	48
Ø50	Ídráttarrör	m	40
Ø20	Blástursrör	m	40
Borði	Varúð, fjarskipti	m	22



Lykilmynd 1:10.000

4xØ110 þverunarrör  
Blástursrör skulu liggja í syðsta röri

Beygjur á ídráttar- og blástursrörum skulu ekki vera krappar

2xØ20  
2xØ50  
Skilja skal eftir hankir við verkmörk, merkja og innmæla

Ljósastólpi

Tengja skal 2xØ20 og 2xØ50 inn í fjarskiptabrunn Núv. fjarskiptabrunnur

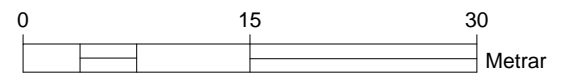

ÚTG.	DAGS.	ÚTGÁFUERILL	HANNAÐ	TEIKN.	YFIRF.
-	-	-	-	-	-
-	-	-	-	-	-
-	-	-	-	-	-
-	-	-	-	-	-



TEIKNINÚMÉR: 2839-046  
430

BLADSTÆRD: A2

HANNAÐ: ETS  
TEIKNAD: ETS  
YFIRFARID: SOU

DAGS: 14.05.2021









MÆLIKVARÐI: 1:500

ÚTGÁFA: Ú

**Selfossveitur**  
Suðurhólar - Austurhólar  
Fjarskipti  
Grunnmynd

SAMPYKKT:  
Kennitala:

# Skýringar: Rafmagn

-  Núverandi stólpi
-  8m stólpi
-  Mælaskápur f. götulýsingu
-  Langmúffa
-  Strengur ótengdur í stólpa (rof)
-  Fjarlæging/færsla á núv. streng
-  Nýr götuljósastr. 5x10q Cu + jarðvír
-  Heimtaug
-  Rör  $\varnothing 110\text{mm}$

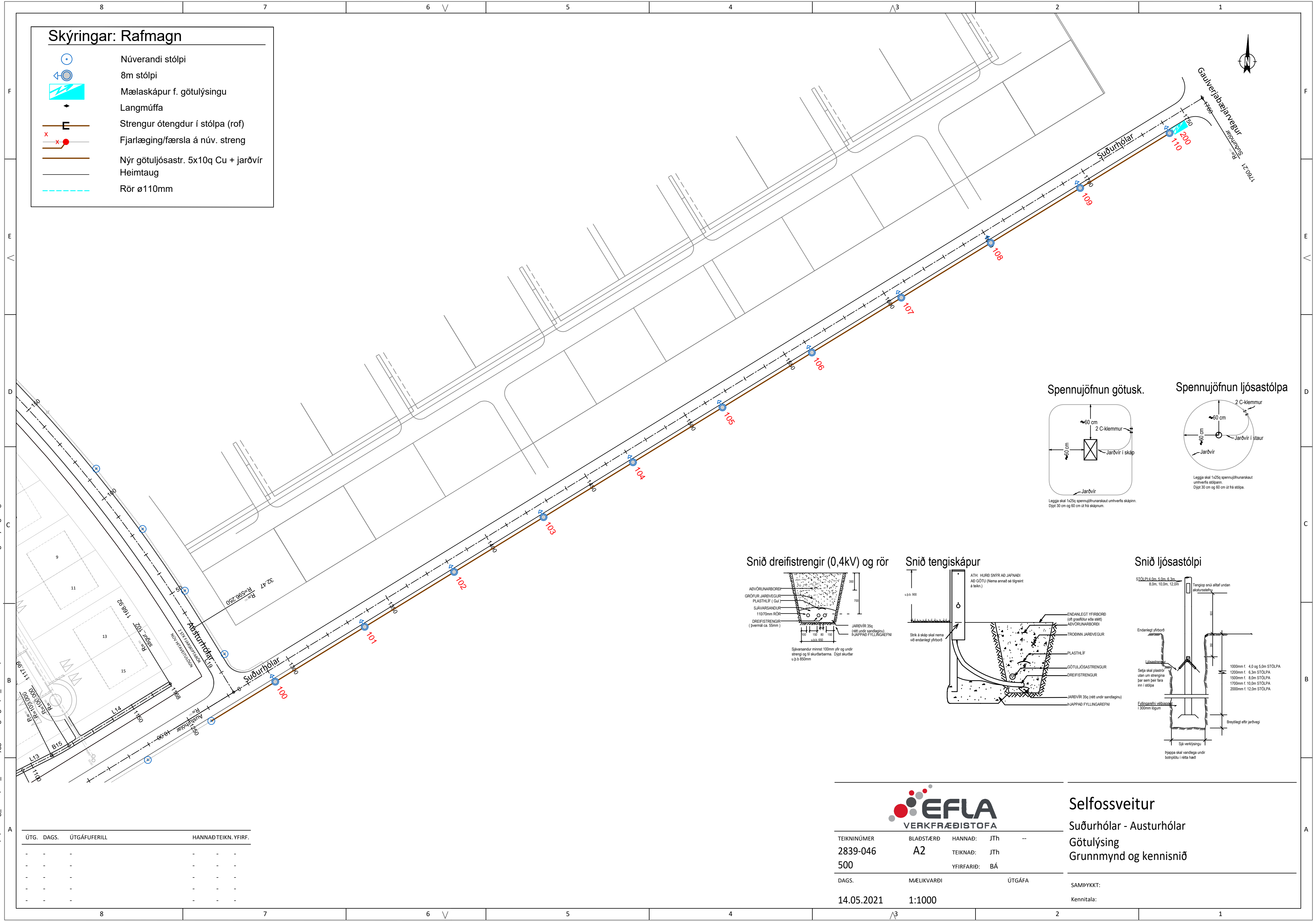

### Spennujöfnun götusk.

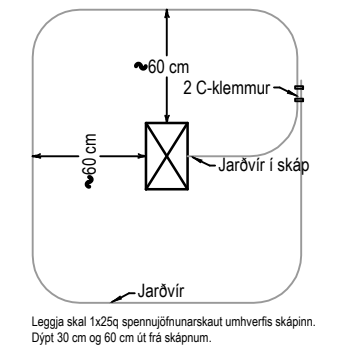

### Spennujöfnun ljósaastólpa

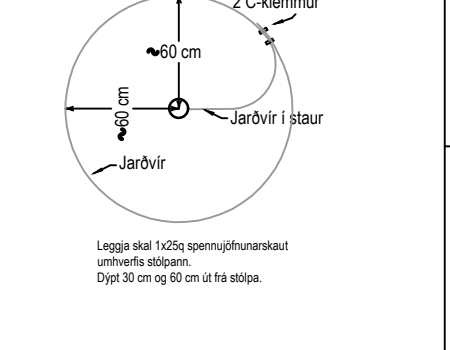

### Snið dreifistrengir (0,4kV) og rör

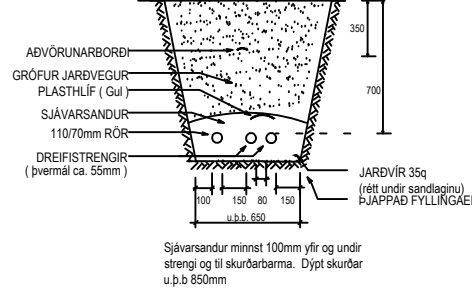

### Snið tengiskápur

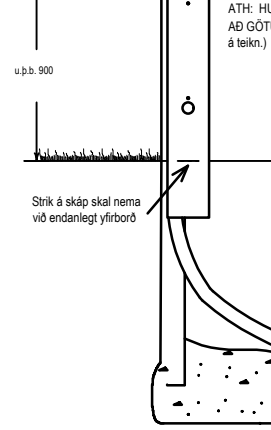

### Snið ljósaastólpi

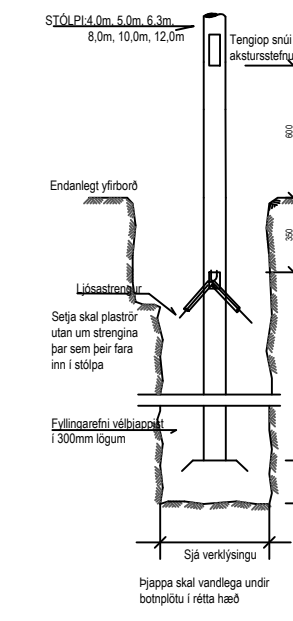

15.5.2021 15:44:19 O:\Arbörg\_2839\046\_Austurbýggð - Frágangur\01\_Hönnun\2839-046-03-TEI-005-V01-Suðurnhólar götulýsing.dwg

ÚTG.	DAGS.	ÚTGÁFUERILL	HANNAÐ TEIKN. YFIRF.
-	-	-	-
-	-	-	-
-	-	-	-
-	-	-	-
-	-	-	-



**Selfossveitur**  
Suðurnhólar - Austurnhólar  
Götulýsing  
Grunnmynd og kennisnið

TEIKNINÚMÉR	BLADSTÆRD	HANNAD:	JTh	--
2839-046	A2	TEIKNAD:	JTh	
500		YFIRFARIÐ:	BÁ	
DAGS.	MÆLIKVARÐI	ÚTGÁFA		
14.05.2021	1:1000			

SAMPYKKT:  
Kennitala: